

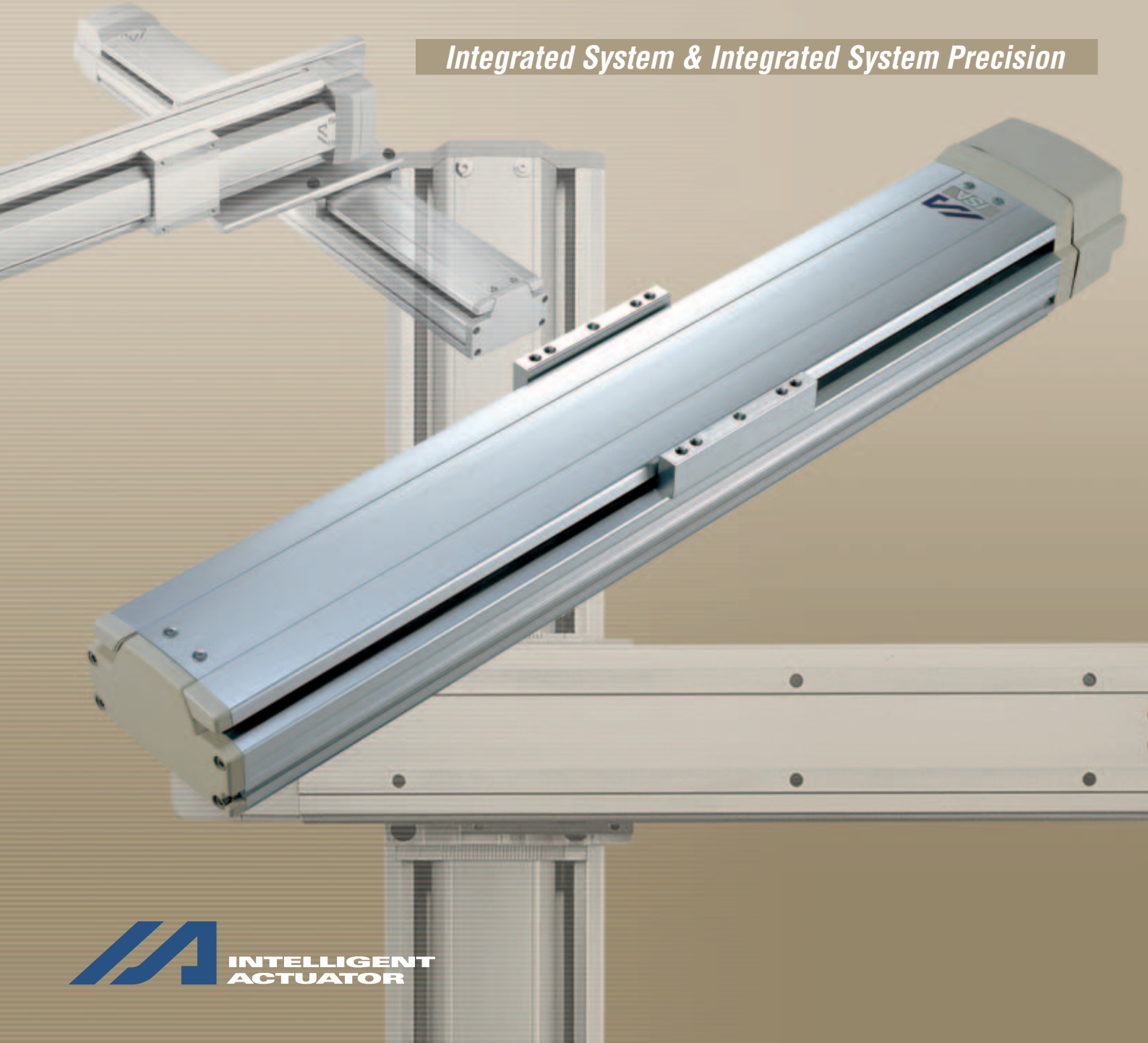

LINEAR AXIS **ISA/ISPA**

Integrated System & Integrated System Precision





VISUAL INDEX

Single-Axis Robots

High-precision positioning systems with a linear positioning repeatability of 0.01 to 0.02 mm

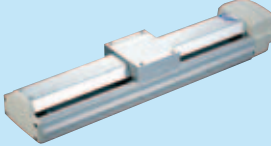
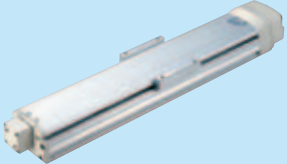
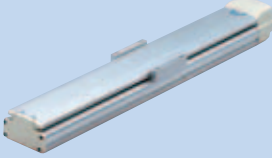
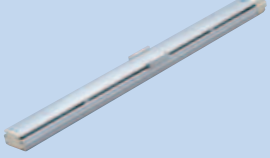
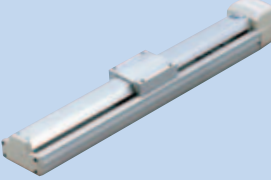
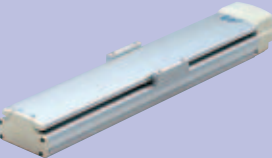

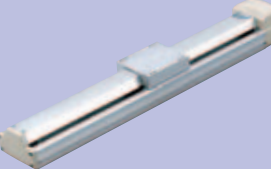
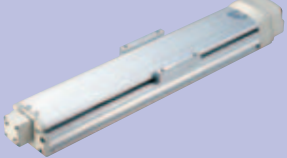
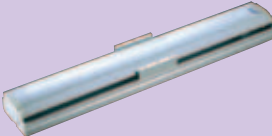
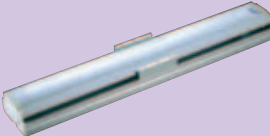

	X-Axis		Y-Axis	Z-Axis
	Standard Type	Mid-Support Type		
Compact Actuator width 90mm	ISA-SXM ISPA-SXM  P13	(Not available)	ISA-SYM ISPA-SYM  P14	ISA-SZM ISPA-SZM  P15
	Medium Actuator width 120mm	ISA-MXM ISPA-MXM  P16, P17	ISA-MXMX ISPA-MXMX  P18	ISA-MYM ISPA-MYM  P19, P20
Large Actuator width 150mm	ISA-LXM ISPA-LXM  P23, P24	ISA-LXMX ISPA-LXMX  P25, P26 ISA-LXUWX ISPA-LXUWX  P27, P28	ISA-LYM ISPA-LYM  P29, P30	ISA-LZM ISPA-LZM  P31, P32
	Super Large Actuator width 198mm	ISA-WXM ISPA-WXM  P33, P34	ISA-WXMX ISPA-WXMX  P35, P36	(Not available)

Application Examples of Combined Axes

Transfer/positioning systems combining single-axis actuators into a two to three orthogonal axes configuration.

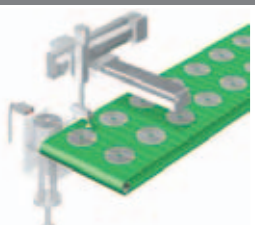
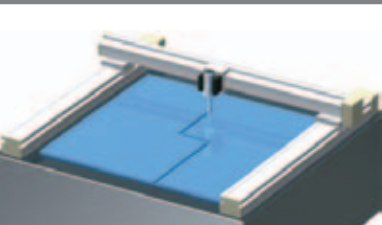
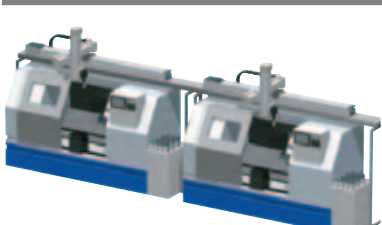
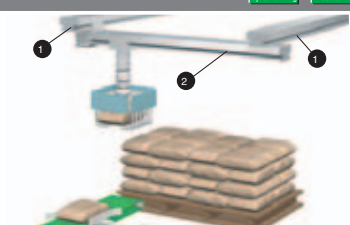
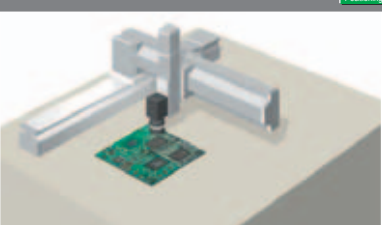
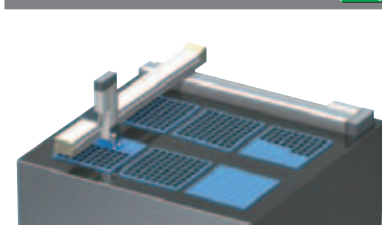
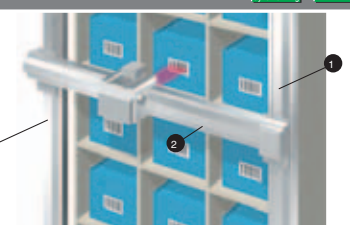
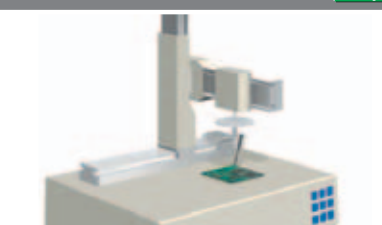
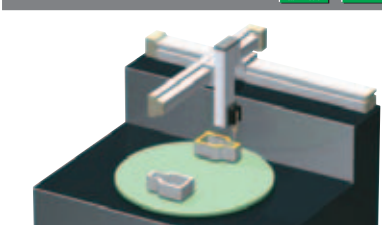
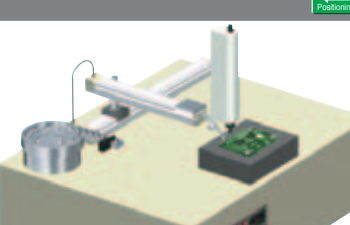
For more informations see the enlarged catalogue "ISPA+ICSPA" with the additional cartesian robots, controllers and options.

<p>CD-Rom Stocking</p>  <p>Incremental Positioning</p> <p>RC Line RCS-RA35 IA Line ICSA2 RCS-RA55</p> <p>Controller RCS-C x 2 X-SEL-K</p>	<p>Cutting</p>  <p>Positioning</p> <p>IA Line ICSA2</p> <p>Controller X-SEL-K</p>	<p>Pick & Place</p>  <p>Positioning</p> <p>IA Line ICSA3</p> <p>Controller X-SEL-K</p>
<p>Palletizing</p>  <p>Synchronizing Positioning</p> <p>IA Line 1 ISPA-WXM 2 ISA-LXM</p> <p>Controller X-SEL-K</p>	<p>Circuit Board Inspection</p>  <p>Positioning</p> <p>IA Line ICSA3</p> <p>Controller X-SEL-K</p>	<p>Parts Transfer</p>  <p>Positioning</p> <p>IA Line ISA-LXM RC Line ISA-MXM RCS-RA55R</p> <p>Controller X-SEL-K</p>
<p>Barcode Reading</p>  <p>Synchronizing Positioning</p> <p>IA Line 1 ISPA-WXM x 2 2 ISA-LYM</p> <p>Controller X-SEL-K</p>	<p>Soldering</p>  <p>Positioning</p> <p>IA Line ICSA2 ISA-SYM</p> <p>Controller X-SEL-K</p>	<p>Dispensing</p>  <p>Path Motion AFM Motion</p> <p>RC Line RCS-R20 IA Line ICSA3</p> <p>Controller E-CON X-SEL-K</p>
<p>Screwdriving</p>  <p>Positioning</p> <p>IA Line ICSA2</p> <p>Controller X-SEL-K</p>	<p>Spraying/Coating</p>  <p>Path Motion</p> <p>IA Line ICSA3</p> <p>Controller X-SEL-K</p>	<p>Unloading</p>  <p>Positioning</p> <p>RC-Line 1 RCP2-RMAx2 2 RCS-SM</p> <p>Controller RCP2-Cx2 RCS-C</p>

Single-Axis Robot ISA/ISPA Series **Features**

The ISA/ISPA is a high-precision positioning system comprised of a base, linear guides, ball screw and AC servo motor. It achieves cost savings, because its design is more comprehensive and adjustment is much easier than when individual components are purchased and assembled.

1 Higher Maximum Acceleration/Deceleration of 1 G (9800 mm/sec²)

Both the ISA and ISPA achieve a maximum acceleration/ deceleration of 1 G, which was heretofore possible only with the ISP Series.

* When accelerating to 2000 mm/sec, a robot operating at an acceleration of 1 G achieves the target speed approx. 0.5 second faster than a robot operating at an acceleration of 0.3 G (as shown in the graph at right).

Acceleration/deceleration indicates the rate of change of speed. 1 G is equivalent to 9800 mm/sec², or the ability to accelerate (or decelerate) 9800 mm/sec per second.

■ Comparison of Acceleration Time at 1 G and 0.3 G

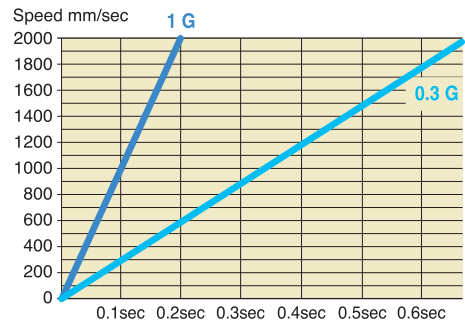

2 Dedicated X/Y/Z-Axes

Dedicated axes are available to choose from according to your specific need.

X-Axis Type (SXM, MXM, LXM, etc.)

- A dedicated cover prevents intrusion of small parts and other foreign objects from above.
- To install the actuator, open the cover and affix with bolts from above.

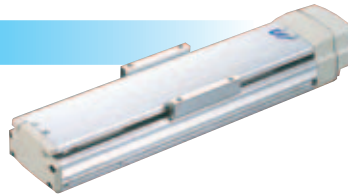

Y-Axis Type (SYM, MYM, LYM, etc.)

- A cover shape is adopted to prevent intrusion of small parts and other foreign objects from above when the actuator is installed on its side.

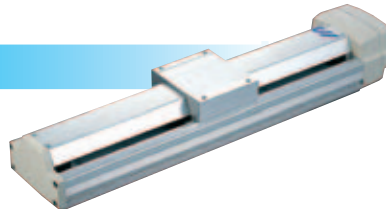

Z-Axis Type (SZM, MZM, LZM, etc.)

- The actuator comes standard with a slider anti-drop brake by assuming use in a vertical application.
- The mounting holes provided in the back of the base (actuator-mounting surface) are different from the mounting holes of the X-axis type.
(A load can be attached easily to the base surface when the actuator is moved vertically.)

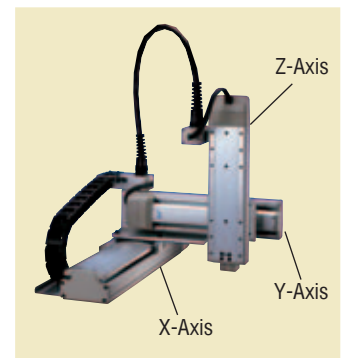
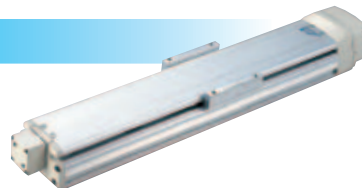

3 Achieving Higher Rigidity with Smaller Size via Base-Integrated Guide Structure

The thickness of the actuator has been reduced by embedding the guide rails in the base. The base also employs a hollow box structure for improved rigidity.

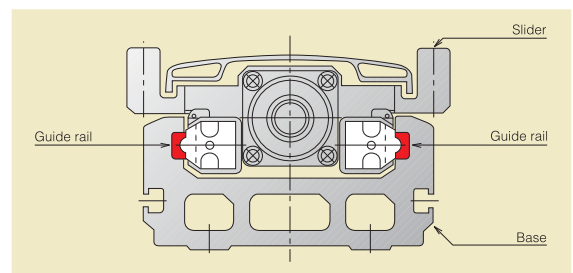

4 2500-mm Stroke with Ball Screw, Achieved with Mid-Support Mechanism

A ball screw drive actuator is prone to screw deflection when the stroke is increased, which makes it difficult to increase the rotating speed and therefore the actuator speed. As a result, belt drive has been the mainstream drive mechanism for long-stroke actuators.

The ISA/ISPA Series achieves a long stroke of 2500 mm using a ball screw drive, employing an original (patented) mid-support mechanism.

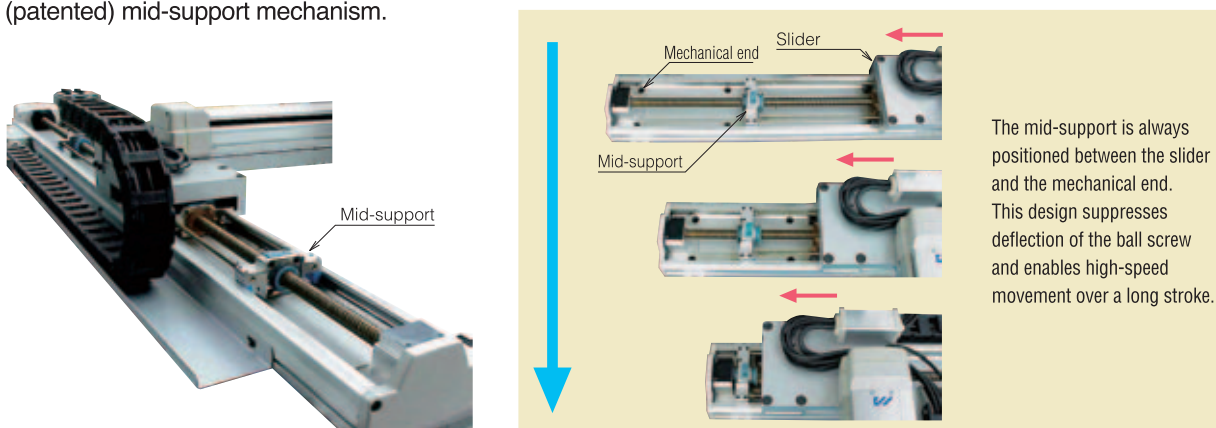

5 Direct Coupling Structure at Same Overall Length as Integrated Ball Screw Type

The ISA/ISPA Series features a coupling structure of the same overall length as the conventional IS Series (integrated ball screw type). This structure allows for motor replacement in the event of a motor problem.

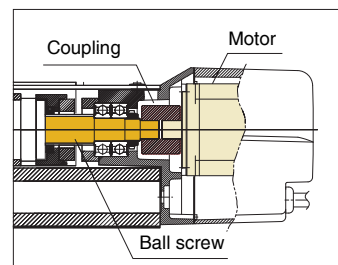

6 Selectable Controller Depending on Desired Control Method

The following three controller types are available:

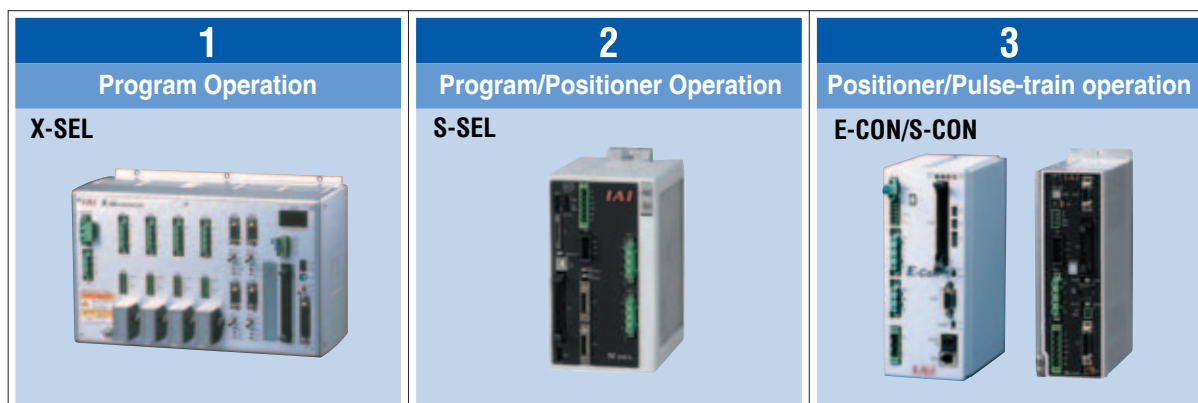

Single-Axis Robot Series Specification Table

	Stroke (mm), maximum speed (mm/sec) (Note 1)																									Load capacity (Note 2)		Motor capacity	Lead	Model	Page
																										Horizontal	Vertical	(W)	(mm)		
	100	200	300	400	500	600	700	800	900	1000	1100	1200	1300	1400	1500	1600	1700	1800	1900	2000	2100	2200	2300	2400	2500	(kg)	(kg)				
ISA ISPA	800																									12	3	60	16	ISA(ISPA)-SXM-□-60-16-***	P13
	400																									25	6		8	ISA(ISPA)-SXM-□-60-8-***	
	200																									50	14		4	ISA(ISPA)-SXM-□-60-4-***	
	800																									12	3	60	16	ISA(ISPA)-SYM-□-60-16-***	P14
	400																									25	6		8	ISA(ISPA)-SYM-□-60-8-***	
	200																									50	14		4	ISA(ISPA)-SYM-□-60-4-***	
	400																									-	6	60	8	ISA(ISPA)-SZM-□-60-8-***-B	P15
	200																									-	14		4	ISA(ISPA)-SZM-□-60-4-***-B	
	1000																									20	5	100	20	ISA(ISPA)-MXM-□-100-20-***	P16
	500																									40	9		10	ISA(ISPA)-MXM-□-100-10-***	
	250																									80	19		5	ISA(ISPA)-MXM-□-100-5-***	
	1500																									25	6	200	30	ISA(ISPA)-MXM-□-200-30-***	P17
	1000																									40	9		20	ISA(ISPA)-MXM-□-200-20-***	
	500																									80	19		10	ISA(ISPA)-MXM-□-200-10-***	
	1500																									25	-	200	30	ISA(ISPA)-MXMX-□-200-30-***	P18
	1000																									40	-		20	ISA(ISPA)-MXMX-□-200-20-***	
	1000																									20	5	100	20	ISA(ISPA)-MYM-□-100-20-***	P19
	500																									40	9		10	ISA(ISPA)-MYM-□-100-10-***	
	250																									80	19		5	ISA(ISPA)-MYM-□-100-5-***	
	1500																									25	6	200	30	ISA(ISPA)-MYM-□-200-30-***	P20
	1000																									40	9		20	ISA(ISPA)-MYM-□-200-20-***	
	500																									80	19		10	ISA(ISPA)-MYM-□-200-10-***	
	500																									-	9	100	10	ISA(ISPA)-MZM-□-100-10-***-B	P21
	250																									-	19		5	ISA(ISPA)-MZM-□-100-5-***-B	
	500																									-	19	200	10	ISA(ISPA)-MZM-□-200-10-***-B	P22
	1000																									40	9		20	ISA(ISPA)-LXM-□-200-20-***	
	500																									80	19	200	10	ISA(ISPA)-LXM-□-200-10-***	P23
	2000																									40	9		40	ISA(ISPA)-LXM-□-400-40-***	
	1000																									80	19	400	20	ISA(ISPA)-LXM-□-400-20-***	P24
	1000																									40	-		200	20	
	2000																									40	-	400	40	ISA(ISPA)-LXMX-□-400-40-***	P26
	1000																									80	-		200	20	
	1000																									40	-	200	20	ISA(ISPA)-LXWX-□-200-20-***	P27
	2000																									40	-		400	40	
	1000																									80	-	400	20	ISA(ISPA)-LXWX-□-400-20-***	P28
	1000																									40	9		200	20	
500																									80	19	200	10	ISA(ISPA)-LYM-□-200-10-***	P29	
2000																									40	9		400	40		ISA(ISPA)-LYM-□-400-40-***
1000																									80	19	400	20	ISA(ISPA)-LYM-□-400-20-***	P30	
500																									-	19		100	10		ISA(ISPA)-LZM-□-200-10-***-B
500																									-	39	400	10	ISA(ISPA)-LZM-□-400-10-***	P31	
2000																									60	14		40	ISA(ISPA)-WXM-□-600-40-***		
1000																									120	29	600	20	ISA(ISPA)-WXM-□-600-20-***	P33	
500																									150	60		10	ISA(ISPA)-WXM-□-600-10-***		
2000																									60	14	750	50	ISA(ISPA)-WXM-□-750-50-***	P34	
1000																									120	29		25	ISA(ISPA)-WXM-□-750-25-***		
2000																									60	-	600	40	ISA(ISPA)-WXMX-□-600-40-***	P35	
1000																									120	-		20	ISA(ISPA)-WXMX-□-600-20-***		
2000																									60	-	750	50	ISA(ISPA)-WXMX-□-750-50-***	P36	
1250																									120	-		25	ISA(ISPA)-WXMX-□-750-25-***		

(Note 1) The figure in the elongated circle indicates the maximum speed for each stroke. (Note 2) The load capacity is based on actuator operation at the rated acceleration (refer to page 7).

Single-Axis Robot Series System Configurations

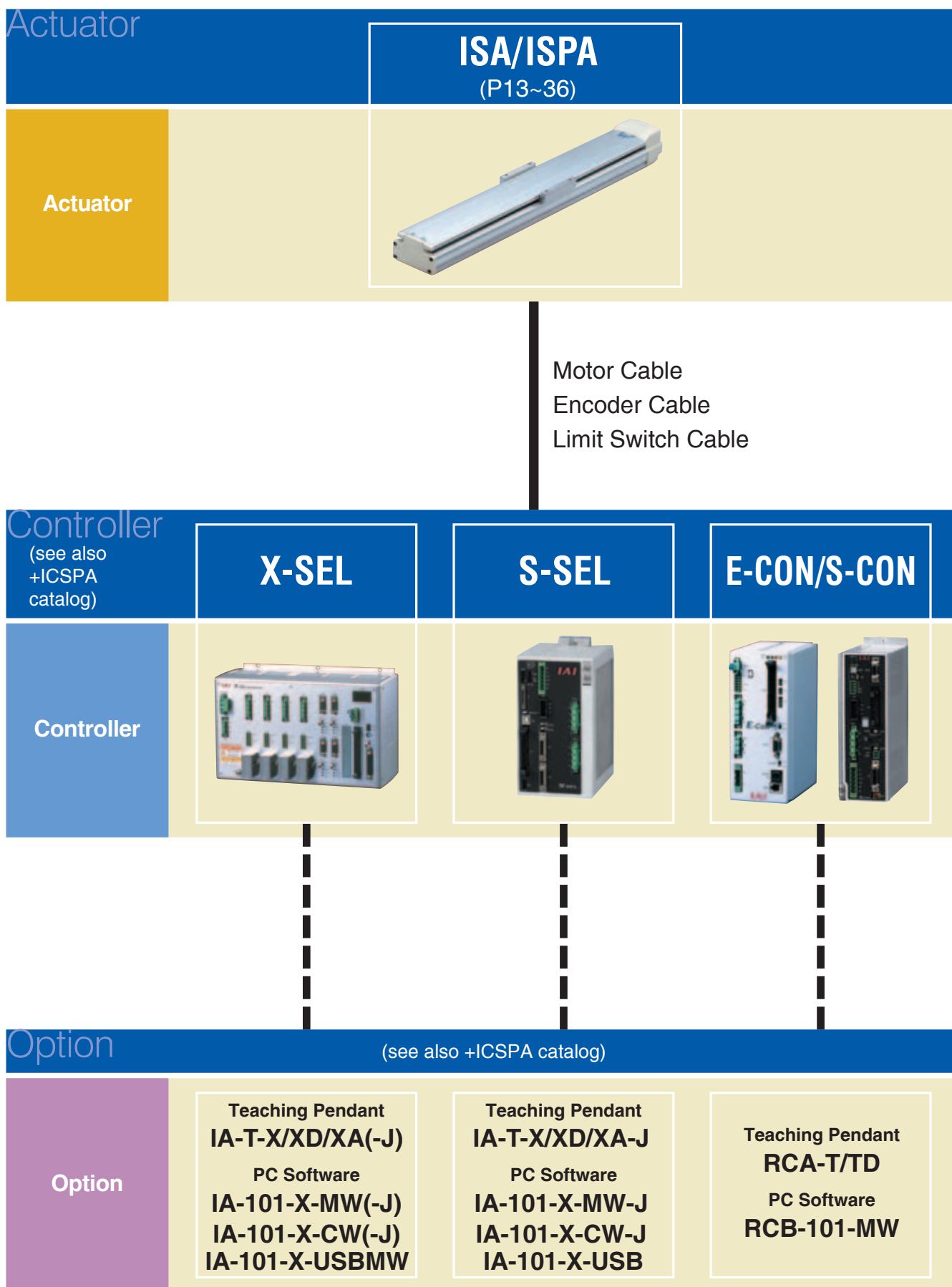

Single-Axis Robot Series **Points to Note**

Notes on Catalog Specifications

Speed

"Speed" refers to the specified speed at which the actuator slider will move. The slider accelerates from a stationary state, and once the specified speed is reached it will maintain that speed until the specified position (immediately before the target position), where it will begin decelerating to stop at the target position.

< Caution >

- ① The maximum speed of the ISA/ISPA Series will remain the same even when the load placed on the slider is changed.
- ② The time needed to reach the specified speed will vary according to the acceleration (deceleration).
- ③ If the travel distance is short, the specified speed may not be reached.
- ④ With a long-stroke axis, the maximum speed will drop to avoid reaching a dangerous speed.
(If you are using a 600 or longer stroke, check the maximum speed for the applicable stroke in the corresponding dimensional drawing.)
- ⑤ When calculating the travel time, consider acceleration, deceleration and stabilization periods in addition to the travel time at the specified speed. (Refer to pages 39 and 40 for the method to calculate travel time.)
- ⑥ Speed can be set in increments of 1 mm/sec in a program.

Acceleration/ Deceleration

"Acceleration" refers to the rate of change of speed when the speed rises from zero (stationary state) to the specified speed.

"Deceleration" refers to the rate of change of speed when the specified speed drops to zero (stationary state).

< Caution >

- ① Increasing the acceleration (deceleration) will shorten the duration the actuator accelerates (decelerates) and decrease the travel time. However, doing so will also cause rapid acceleration (deceleration), resulting in increased shock.
- ② The rated acceleration is 0.3 G (or 0.15 G if the lead is 4 or 5 mm).
(The load capacity is set based on the rated acceleration.)
- ③ If the ISA/ISPA Series is operated at an acceleration (deceleration) exceeding the rated acceleration, the load capacity will drop.
(Refer to page 40 for details.)
- ④ Acceleration can be set in increments of 0.01 G in a program.

Duty

IAI recommends that our actuators be used at a duty of 50% or less as a guideline in view of the relationship of service life and accuracy.

$$\text{Duty (\%)} = \frac{\text{Motion time}}{\text{Motion time} + \text{Inactivity}} \times 100$$

Positioning Repeatability

"Positioning repeatability" refers to the positioning accuracy of repeated movements to a pre-stored position. **This is not the same as "absolute positioning accuracy," so exercise caution.**

Positioning repeatability

Accuracy variation of the stop position when positioning is performed repeatedly to the same point.

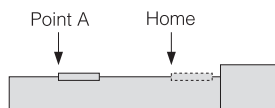

Absolute positioning accuracy

Difference between the coordinate value and the measured value when positioning is performed to a given positioning point specified by coordinates.

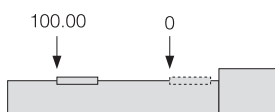

Single-Axis Robot Series **Points to Note**

Notes on Catalog Specifications

Home

The home is set on the motor side for the standard specification, or on the counter-motor side for the reversed-home specification.

- The incremental actuator always requires homing every time the power is reconnected.
- During homing the slider will move to the mechanical end before reversing, so be careful to prevent contact with surrounding parts.
- To change the home direction, the controller parameters must be changed.

Allowable Load Moments (Ma, Mb, Mc)

Each allowable load moment is calculated by assuming the service life of the guide as 10,000 km. Applying a moment exceeding the specified value will reduce the life of the guide, so exercise caution.

Directions of load moment for slider type

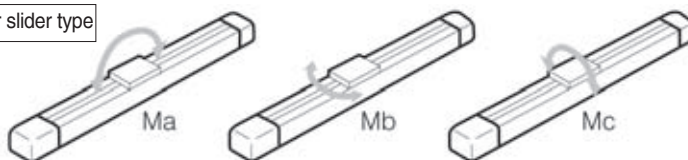

Overhung Load Length (L)

"Overhung load length" refers to a reference offset at which the actuator can operate smoothly when a load, bracket, etc., is installed at a position offset from the actuator/slider center.

When each model is used with an overhung load exceeding the allowable length, vibration or stabilization delay may result. Therefore, be sure to keep the overhung load length within the allowable value.

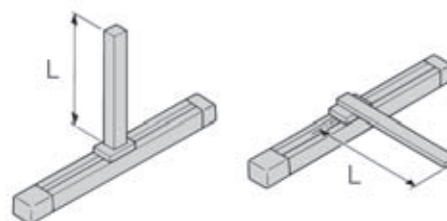

Actuator Accuracy

The accuracy of the ISA/ISPA-Series actuators is specified below.

The side and bottom faces of the actuator base provide reference surfaces for slider travel. Use them to adjust parallelism when installing the actuator.

and load-mounting surface (top face)
±0.05 mm/m or less



Parallelism when mounted on frame (when the actuator is mounted to a flat surface ¹⁾)
±0.05 mm/m or less

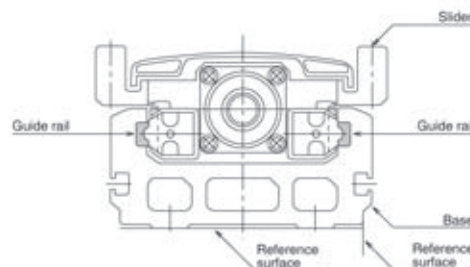
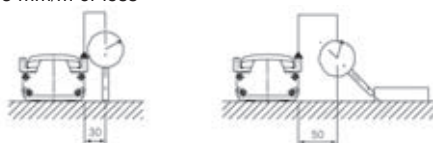

Condition: The above values are applicable at 20°C. ¹⁾ Flatness: 0.05 mm or less

Explanation of Model Specification Items

Refer to the right page for the explanation of each model specification item.
The selection range for each item will vary depending on the actuator type. For details, refer to the page corresponding to each actuator type.

(1)	(2)	(3)	(4)	(5)	(6)	(7)	(8)	(9)
Series	Type	Encoder type	Motor output	Lead	Stroke	Applicable controller	Cable length	Options
ISA ISPA	SXM SYM	A I	60	4 8 16	100 ~ 600	T1 T2	N S M X□□	AQ B C CL L LL LLM LM NM RT S EU
	SZM			4 8				
	MXM MYM		100	5 10 20				
			200	10 20 30				
	MZM		100	5 10				
			200	10				
	MXMX		200	20 30	800 ~ 2000			
	LXM LYM		200	10 20	100 ~ 1200			
			400	20 40				
	LZM		200	10				
			400	10				
	LXMX		200	20	1000 ~ 2500			
			400	20 40				
	LXUWX		200	20				
			400	20 40				
	WXM		600	10 20 40	100 ~ 1300			
			750	25 50				
	WXMX		600	20 40	900 ~ 2500			
			750	25 50				

(1) Series

Indicate the name of each series.

(2) Type

Indicate the classification by size (S, M, L or W), shape (X, Y or Z), etc.

(3) Encoder type

Indicate whether the encoder installed in the actuator is an "absolute type" or "incremental type."

A: Absolute type Since the current slider position will be retained after the power is turned off, homing is not required when the actuator is powered up.

I: Incremental type Since the slider position data are cleared when the power is turned off, homing must be performed every time the actuator is powered up.

(4) Motor output

Indicate the output of the motor installed in the actuator in watts.

(5) Lead

Indicate the ball screw lead.
"Lead" refers to the distance the slider will move when the ball screw rotates by one revolution.
The larger the lead, the faster the maximum speed becomes.

(6) Stroke

Indicate the actuator stroke (range of operation) in millimeters.

(7) Applicable controller

Indicate the type of controller that can be used with the actuator.

T1: X-SEL-KE/KT, E-CON
T2: X-SEL-P/Q, S-SEL, S-CON

(8) Cable length

Indicate the length of the motor/encoder cable connecting the actuator and the controller.

N : No cable

S : 3m

M : 5m

X□□: Use this field when a length other than 3 m and 5 m is specified.

(Example X08 : 8m)

* The standard cable is a robot cable.

(9) Actuator Accuracy

Indicate a desired option(s) to be equipped on the actuator. Refer to pages 11 and 12 for the explanation of each option.

* When selecting multiple options, specify them in alphabetical order (e.g., AQ-B-L-NM).

- AQ : [AQ seal] A unit that supplies lubricant to the sliding sections of the ball screw and guide.
- B : [Brake] A brake for preventing the slider from falling in a vertical application when the power or servo is turned off.
- C : [Creep sensor] A sensor for increasing the homing speed and thereby decreasing the homing time.
- CL : [Creep sensor on opposite side] The creep sensor is normally installed on the right side as viewed from the motor.
Select this option if you want to install the sensor on the left side.
- L : [Home limit switch] A limit switch for completing homing by reversing the slider using a sensor, not by the normal contact method, during homing.
- LL : [Home limit switch on opposite side] Similarly to the creep sensor on opposite side option, select this option if you want to install the limit switch on the opposite side.
- LM : [Master-axis designation] Specify this option for the axis to be used as the master in synchronized operation.
- S : (required).
- LLM : [M master axis used in synchronized operation.
- NM : [Reverse-homing specification] Normally the home is set on the motor side. Select this option to specify the home on the counter-motor side.
- RT : [Guide with ball-retaining mechanism] A mechanism for reducing noise while extending the service life of the guide by inserting a spacer (retention device) between guide balls.
- EU : [Metal cablejoint connector] Select this option for a motor/encoder cable with metal cable plugs (see page 13).
Without this option plastic plugs are default. By this option cable lengths to 5 m are without surcharge, too.

Options

AQ: [AQ seal]

The AQ seal is a lubrication unit that utilizes lubrication material made of resin-solidified lubricant.

The porous material impregnated with a large amount of lubricant allows lubricant to ooze out onto its surface via the capillary effect.

Lubricant is supplied when the AQ seal is pushed against the guide or ball-screw surface (steel-ball rolling surface). Combined use of the AQ seal and grease helps achieve maintenance-free operation for a long period.

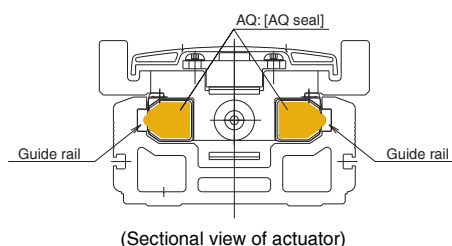

(Sectional view of actuator)

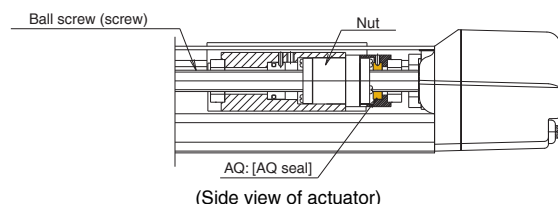

(Side view of actuator)

B: [Brake]

A retention mechanism that prevents the slider from falling and damaging the load when the power or servo is turned off in a vertical actuator application.

The S, M and L-type Z-axis actuators of the ISA/ISPA Series (SZM, MZM and LZM) are designed for use in a vertical application and therefore come standard with a brake.

If any axis other than the Z-axis is to be used vertically, install an optional brake.

For the S, M and L types, the brake is installed on the outside of the end cover on the counter-motor side (refer to the drawing of each model). The brake is installed inside the actuator only for the W type.

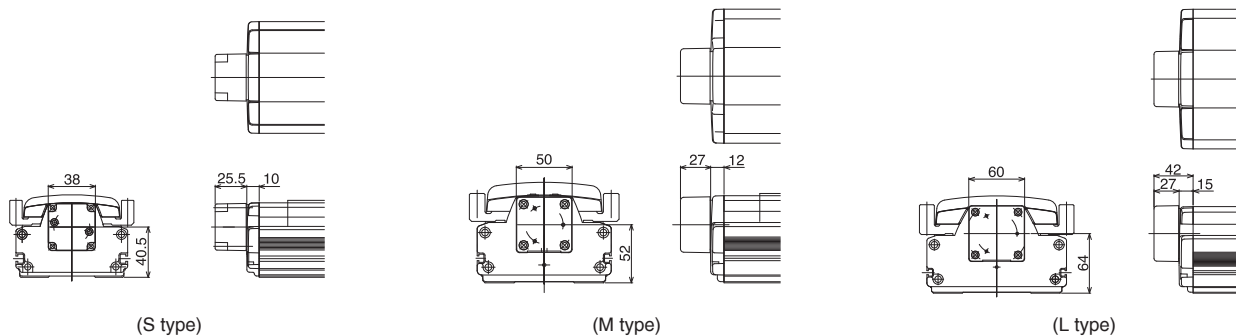

C: [Creep sensor]

A sensor used for achieving high-speed homing.

Normally during homing, the slider is caused to contact the stopper at the motor-side stroke end and then reverse, so the homing speed is kept to between 10 and 20 mm/s.

For this reason, it takes time to complete homing when the stroke is long. This proximity sensor reduces the homing time by allowing the slider to return at high speed and then reducing the speed to the normal homing speed just before homing is completed.

The standard installation position of this sensor is on the right side of the actuator as viewed from the motor (option code: C) (refer to the limit switch drawing on the right page).

A cover similar to that for the limit switch is provided on the outside of the sensor. To install the sensor on the opposite side, select CL (opposite side specification).

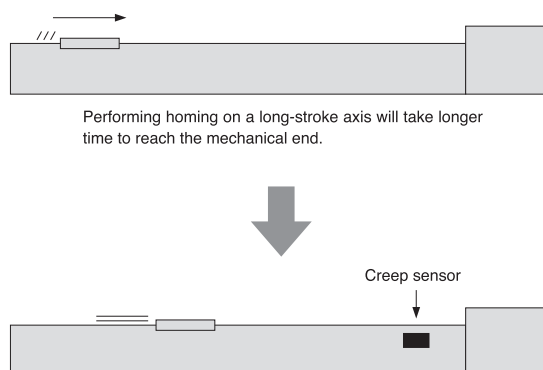

A sensor is provided before the mechanical end, and upon detection of the sensor the speed will be reduced to the normal homing speed.

Options

LL: [Home limit switch on opposite side]

The normal homing operation of the ISA/ISPA Series conforms to the "contact method," whereby the slider is caused to contact the stopper and then reverse, after which the Z phase will be detected and set as the home.

Option L (home limit switch) achieves this homing operation by letting the slider reverse upon proximity sensor detection, without contacting the stopper. When this option is specified, three proximity sensors of HOME (for home detection), +OT (counter-motor side overtravel) and -OT (motor-side overtravel) will be installed. Use this option if you want to fine-tune the reversing position.

The standard installation position of the home limit switch and cover is on the right side of the actuator as viewed from the motor (option code: L).

To install the switch on the opposite side, select LL (opposite side specification).

*The ISP-W and ISPDCR-W come standard with a limit switch. Since the limit switch is installed inside the actuator, no cover will be provided on the side face of the actuator (creep sensor is also housed in the actuator).

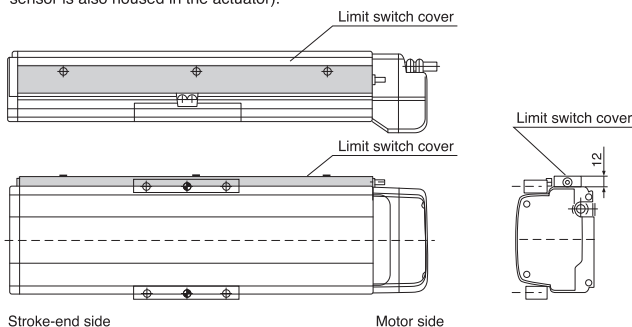

LM: [Master-axis designation in synchronized operation]

"Synchronized operation function" is one of the functions provided by the X-SEL controller.

It allows two actuator axes to operate simultaneously, with one axis acting as the master (option code: M) and the other as the slave (option code: S). The slave follows the master by super-high speed processing control to achieve simultaneous operation of the two axes. The two actuator axes used in synchronized operation must have the same specifications (type, lead motor output and stroke). When performing synchronized operation, the master axis must be of the limit switch specification. Therefore, specify LM (limit-switch master-axis designation) for the master axis and S (slave-axis designation) for the slave axis.

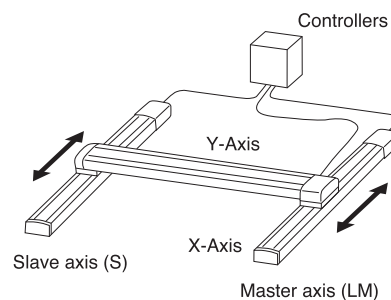

NM: [Reverse homing specification]

With the ISA/ISPA Series, the standard home direction is the motor side. To change the home direction, the encoder must be adjusted. If you prefer a reverse homing specification, specify it when placing an order.

RT: [Guide with ball-retaining mechanism]

A spacer (retainer) is inserted between guide balls (steel balls) to reduce noise while extending the service life of the guide. The spacer eliminates annoying metal noise caused by colliding balls. Since wear due to ball friction decreases, the service life of the guide will increase. Elimination of ball contact will make the guide movement smoother, resulting in improved slider operability.

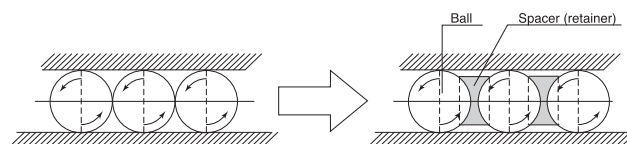
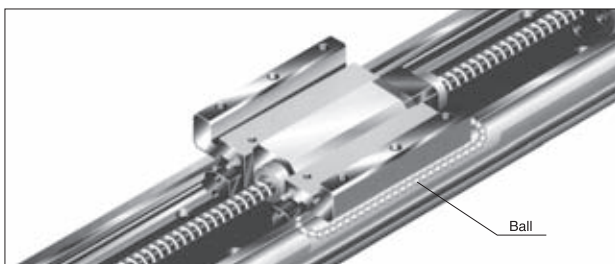

S: [Slave-axis designation in synchronized operation]

Specify this option for the axis to be used as the slave in synchronized operation. Refer to the explanation of LM (master-axis designation in synchronized operation) for details.

ISA-SXM Single-Axis Robot: Compact X-Axis Type, Actuator Width 90mm, 60W, Straight Shape
ISPA-SXM Single-Axis Robot: Compact X-Axis Type, Actuator Width 90mm, 60W, Straight Shape
 High-Precision Specification

Type / Compact X-axis (90-mm wide) Stroke / 100~600mm Load capacity / 50kg (horizontal)/14kg (vertical)

Model specification items - Series - Type - Encoder type - Motor output - Lead - Stroke - Applicable controller - Cable length - Options
 ISA [ISPA] - SXM - A - 60 - 16 - 600 - T1 - S - B



* Refer to page 9 for the details of model specification items.

Models/Specifications

Model	Encoder type	Motor output (W)	Lead (mm)	Stroke (mm) In increments of 50mm (Note 1)	Speed (mm/s)	Acceleration (Note 2)				Load capacity (Note 2)				Rated thrust (N)
						Horizontal (G)		Vertical (G)		Horizontal (kg)		Vertical (kg)		
						Rated	Maximum	Rated	Maximum	Rated acceleration	Maximum acceleration	Rated acceleration	Maximum acceleration	
ISA [ISPA] -SXM-A-60-16-***-T1(2)-△□	Absolute	60	16	100~600	1~800	0.3	1.0	0.3	0.7	12	3.5	3	2	63.7
ISA [ISPA] -SXM-A-60-8-***-T1(2)-△□			8		1~400	0.3	0.6	0.3	0.5	25	12	6	5	127.4
ISA [ISPA] -SXM-A-60-4-***-T1(2)-△□			4		1~200	0.15	0.5	0.15	0.3	50	30	14	12	254.8
ISA [ISPA] -SXM-I-60-16-***-T1(2)-△□	Incremental	60	16	100~600	1~800	0.3	1.0	0.3	0.7	12	3.5	3	2	63.7
ISA [ISPA] -SXM-I-60-8-***-T1(2)-△□			8		1~400	0.3	0.6	0.3	0.5	25	12	6	5	127.4
ISA [ISPA] -SXM-I-60-4-***-T1(2)-△□			4		1~200	0.15	0.5	0.15	0.3	50	30	14	12	254.8

* In the above model names, *** indicates the stroke, △ the cable length and □ the applicable options.

*1.0G=9800mm/sec²

Options

Name	Code	Page	Name	Code	Page
AQ seal	AQ	→ P11	Master-axis designation	LM	→ P12
Brake	B	→ P11	Master-axis designation (sensor on opposite side)	LLM	→ P12
Creep sensor	C	→ P11	Reverse homing specification	NM	→ P12
Creep sensor on opposite side	CL	→ P11	Guide with ball-retaining mechanism	RT	→ P12
Home limit switch	L	→ P12	Slave-axis designation	S	→ P12
Home limit switch on opposite side	LL	→ P12	Metal cable joint connector	EU	

Common Specifications

* Refer to page 8 for the details of common specification items.

Positioning repeatability (Note 3)	±0.02mm ±0.01mm]
Drive system (Note 4)	Ball screw ø12mm, rolled C10 [equivalent to rolled C5]
Backlash (Note 5)	0.05mm or less [0.02mm or less]
Guide	Integrated with base
Allowable load moment	Ma: 28.4N•m Mb: 40.2N•m Mc: 65.7N•m
Overhung load length	Ma direction: 450mm or less, Mb/Mc directions: 450mm or less
Base	Material: Aluminum with white alumite treatment
Cable length (Note 6)	N: No cable, S: 3m, M: 5m, X□□ : Length specification

Dimensions

* Note that changing the home direction will require the actuator to be returned to IAI for adjustment.

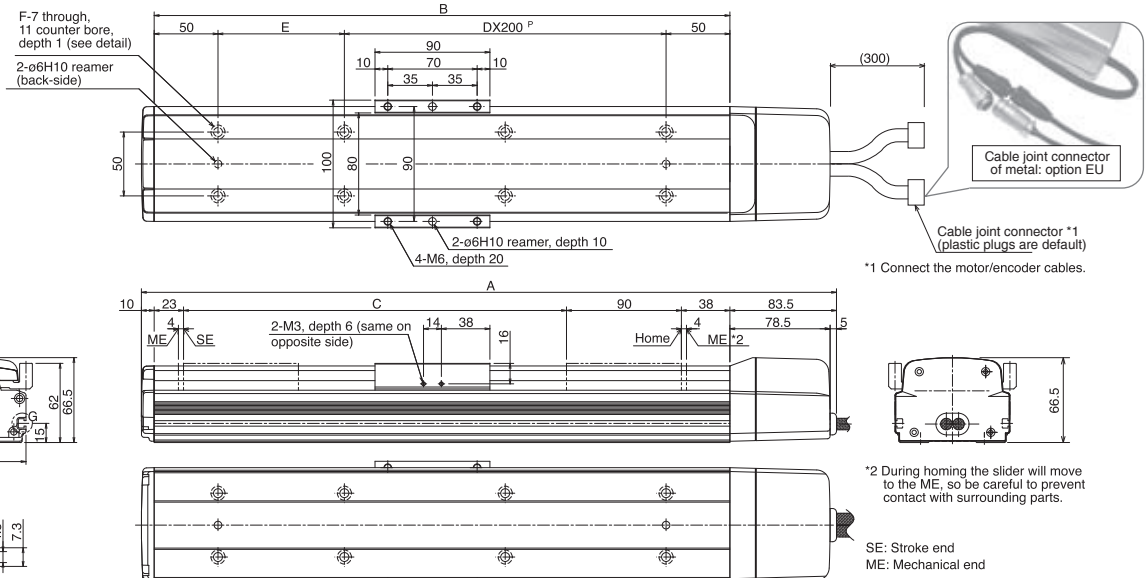

Dimensions, Weight and Maximum Speed by Stroke

Stroke	100	(150)	200	(250)	300	(350)	400	(450)	500	(550)	600
A	344.5	394.5	444.5	494.5	544.5	594.5	644.5	694.5	744.5	794.5	844.5
B	251	301	351	401	451	501	551	601	651	701	751
C	100	150	200	250	300	350	400	450	500	550	600
D	0	0	0	1	1	1	1	2	2	2	2
E	151	201	251	101	151	201	251	101	151	201	251
F	4	4	4	6	6	6	6	8	8	8	8
Weight (kg)	2.8	3.1	3.4	3.7	4.0	4.3	4.6	4.9	5.2	5.5	5.8
Maximum speed (mm/s)	Lead 16	800									
	Lead 8	400									
	Lead 4	200									

Applicable Controller Specifications

Applicable controller	Maximum number of controlled axes	Compatible encoder type	Program operation	Positioner operation	Pulse-train control	Supply voltage
X-SEL(-P/Q)	4(6) axes	Absolute/incremental	○	△		AC100/230V
S-SEL	2 axes	Absolute/incremental	○	△		AC100/230V
S/E-CON	1 axis	Absolute/incremental		○/○	○/-	AC100/230V

Caution

(Note 1) The strokes that are set in increments of 50 mm are semi-standard settings.
 (Note 2) Refer to page 38 for the relationship of acceleration and load capacity.
 (Notes 3, 4, 5) The figures in brackets apply to the ISPA Series.
 Other specification values apply to both the ISA and ISPA Series.
 (Note 6) The maximum cable length is 30 m. Specify the desired length in meters (e.g., X08 = 8 m).

* Refer to page 7 for other points to note.

ISA-SYM Single-Axis Robot: Compact Y-Axis Type, Actuator Width 90mm, 60W, Straight Shape

ISPA-SYM Single-Axis Robot: Compact Y-Axis Type, Actuator Width 90mm, 60W, Straight Shape
High-Precision Specification

Type Compact Y-axis (90-mm wide) Stroke 100-600mm Load capacity 50kg (horizontal)/14kg (vertical)

n Model specification items — Series — Type — Encoder type — Motor output — Lead — Stroke — Applicable controller — Cable length — Options

ISA[ISPA] - SYM - A - 60 - 16 - 600 - T1 - S - B



* Refer to page 9 for the details of model specification items.

Models/Specifications

Model	Encoder type	Motor output (W)	Lead (mm)	Stroke (mm) In increments of 50mm (Note 1)	Speed (mm/s)	Acceleration (Note 2)				Load capacity (Note 2)				Rated thrust (N)
						Horizontal (G)		Vertical (G)		Horizontal (kg)		Vertical (kg)		
						Rated	Maximum	Rated	Maximum	Rated acceleration	Maximum acceleration	Rated acceleration	Maximum acceleration	
ISA [ISPA] -SYM-A-60-16-***-T1(2)-△-□	Absolute	60	16	100 - 600	1 ~ 800	0.3	1.0	0.3	0.7	12	3.5	3	2	63.7
ISA [ISPA] -SYM-A-60-8-***-T1(2)-△-□			8		1 ~ 400	0.3	0.6	0.3	0.5	25	12	6	5	127.4
ISA [ISPA] -SYM-A-60-4-***-T1(2)-△-□			4		1 ~ 200	0.15	0.5	0.15	0.3	50	30	14	12	254.8
ISA [ISPA] -SYM-I-60-16-***-T1(2)-△-□	Incremental	60	16	100 - 600	1 ~ 800	0.3	1.0	0.3	0.7	12	3.5	3	2	63.7
ISA [ISPA] -SYM-I-60-8-***-T1(2)-△-□			8		1 ~ 400	0.3	0.6	0.3	0.5	25	12	6	5	127.4
ISA [ISPA] -SYM-I-60-4-***-T1(2)-△-□			4		1 ~ 200	0.15	0.5	0.15	0.3	50	30	14	12	254.8

* In the above model names, *** indicates the stroke, △ the cable length and □ the applicable options.

*1.0G=9800mm/sec²

Options

Name	Code	Page	Name	Code	Page
AQ seal	AQ	Ô P11	Master-axis designation	LM	Ô P12
Brake	B	Ô P11	Master-axis designation (sensor on opposite side)	LLM	Ô P12
Creep sensor	C	Ô P11	Reverse homing specification	NM	Ô P12
Creep sensor on opposite side	CL	Ô P11	Guide with ball-retaining mechanism	RT	Ô P12
Home limit switch	L	Ô P12	Slave-axis designation	S	Ô P12
Home limit switch on opposite side	LL	Ô P12	Metal cable joint connector	EU	→ P13

Common Specifications

* Refer to page 8 for the details of common specification items.

Positioning repeatability (Note 3)	±0.02mm ±0.01mm
Drive system (Note 4)	Ball screw ø12mm, rolled C10 [equivalent to rolled C5]
Backlash (Note 5)	0.05mm or less [0.02mm or less]
Guide	Integrated with base
Allowable load moment	Ma: 28.4Nm Mb: 40.2Nm Mc: 32.8Nm
Overhung load length	Ma direction: 450mm or less, Mb/Mc directions: 450mm or less
Base	Material: Aluminum with white alumite treatment
Cable length (Note 6)	N: No cable, S: 3m, M: 5m, X □ □ : Length specification

Dimensions

* Note that changing the home direction will require the actuator to be returned to IAI for adjustment.

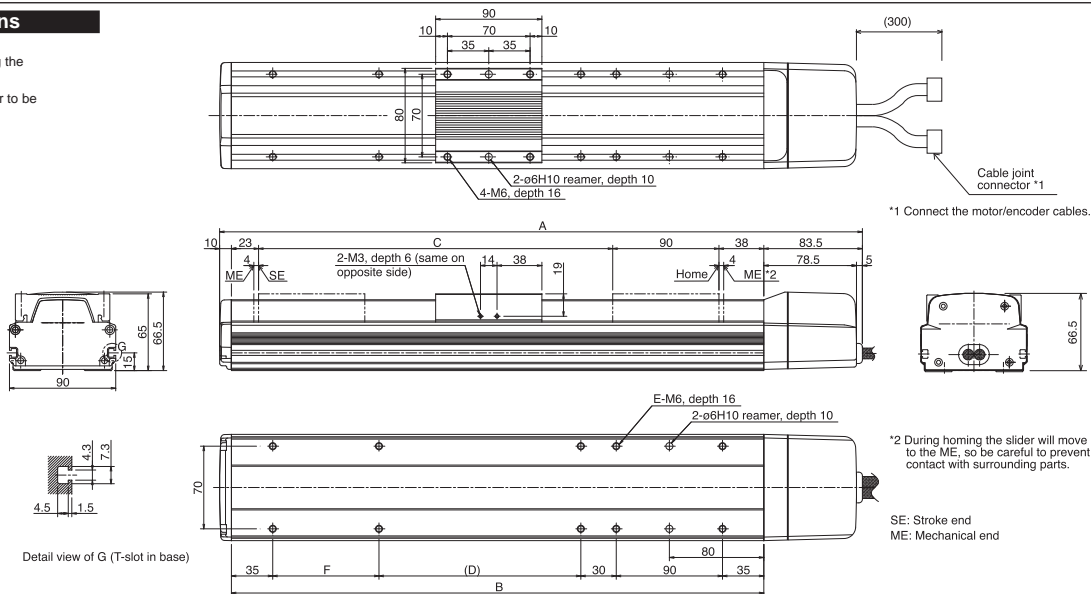

n Dimensions, Weight and Maximum Speed by Stroke

Stroke	100	(150)	200	(250)	300	(350)	400	(450)	500	(550)	600
A	344.5	394.5	444.5	494.5	544.5	594.5	644.5	694.5	744.5	794.5	844.5
B	251	301	351	401	451	501	551	601	651	701	751
C	100	150	200	250	300	350	400	450	500	550	600
D	61	21	71	121	171	221	271	321	371	421	471
E	8	10	10	10	10	10	10	10	10	10	10
F	Ø	90	90	90	90	90	90	90	90	90	90
Weight (kg)	2.8	3.2	3.5	3.9	4.2	4.6	4.9	5.3	5.6	6.0	6.3
Maximum speed (mm/s)	Lead 16	800									
	Lead 8	400									
	Lead 4	200									

Applicable Controller Specifications

Applicable controller	Maximum number of controlled axes	Compatible encoder type	Program operation	Positioner operation	Pulse-train control	Supply voltage
X-SEL(-P/Q)	4(6) axes	Absolute/incremental		§		AC100/230V
S-SEL	2 axes	Absolute/incremental	○	△		AC100/230V
S-/E-CON	1 axis	Absolute/incremental		○/○	○/-	AC100/230V



(Note 1) The strokes that are set in increments of 50 mm are semi-standard settings.
 (Note 2) Refer to page 38 for the relationship of acceleration and load capacity.
 (Notes 3, 4, 5) The figures in brackets apply to the ISPA Series.
 Other specification values apply to both the ISA and ISPA Series.
 (Note 6) The maximum cable length is 30 m. Specify the desired length in meters (e.g., X08 = 8 m).

* Refer to page 7 for other points to note.

ISA-SZM Single-Axis Robot: Compact Vertical-Axis Type, Actuator Width 90mm, 60W, Straight Shape

ISPA-SZM Single-Axis Robot: Compact Vertical-Axis Type, Actuator Width 90mm, 60W, Straight Shape
High-Precision Specification

Type Compact vertical axis (90-mm wide) Stroke 100-600mm Vertical application only (with standard brake) 14kg

Model specification items: Series Type Encoder type Motor output Lead Stroke Applicable controller Cable length Options
ISA[ISPA] - SZM - A - 60 - 16 - 600 - T1 - S - B - L

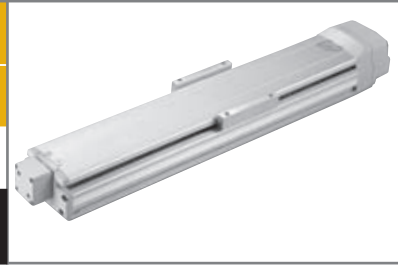

* Refer to page 9 for the details of model specification items.

Models/Specifications

Model	Encoder type	Motor output (W)	Lead (mm)	Stroke (mm) In increments of 50mm (Note 1)	Speed (mm/s)	Acceleration (Note 2)				Load capacity (Note 2)				Rated thrust (N)	
						Horizontal (G)		Vertical (G)		Horizontal (kg)		Vertical (kg)			
						Rated	Maximum	Rated	Maximum	Rated	Maximum	Rated	Maximum		
ISA [ISPA] -SZM-A-60-8-***-T1(2)-△-B-□	Absolute	60	8	100 ~ 600	1 ~ 400	Vertical application only	0.3	0.5	Vertical application only	6	5	127.4			
ISA [ISPA] -SZM-A-60-4-***-T1(2)-△-B-□			4		1 ~ 200								0.15	0.3	14
ISA [ISPA] -SZM-I-60-8-***-T1(2)-△-B-□	Incremental	8	1 ~ 400	0.3	0.5								6	5	127.4
ISA [ISPA] -SZM-I-60-4-***-T1(2)-△-B-□		4	1 ~ 200	0.15	0.3								14	12	254.8

* In the above model names, *** indicates the stroke, △ the cable length and □ the applicable options.

*1.0G=9800mm/sec²

Options

Name	Code	Page	Name	Code	Page
AQ seal	AQ	→ P11	Master-axis designation	LM	→ P12
Brake	B	→ P11	Master-axis designation (sensor on opposite side)	LLM	→ P12
Creep sensor	C	→ P11	Reverse homing specification	NM	→ P12
Creep sensor on opposite side	CL	→ P11	Guide with ball-retaining mechanism	RT	→ P12
Home limit switch	L	→ P12	Slave-axis designation	S	→ P12
Home limit switch on opposite side	LL	→ P12	Metal cable joint connector	EU	→ P13

* The SZM type comes standard with a brake (B).

Common Specifications

* Refer to page 8 for the details of common specification items.

Positioning repeatability (Note 3)	±0.02mm [±0.01mm]
Drive system (Note 4)	Ball screw ø12mm, rolled C10 [equivalent to rolled C5]
Backlash (Note 5)	0.05mm or less [0.02mm or less]
Guide	Integrated with base
Allowable load moment	Ma: 28.4Nm Mb: 40.2Nm Mc: 33.3Nm
Brake	Comes standard with a dry, single-plate, non-excitation type electromagnetic brake.
Base	Material: Aluminum with white alumite treatment
Cable length (Note 6)	N: No cable, S: 3m, M: 5m, X□□ : Length specification

Dimensions

* Note that changing the home direction will require the actuator to be returned to IAI for adjustment.

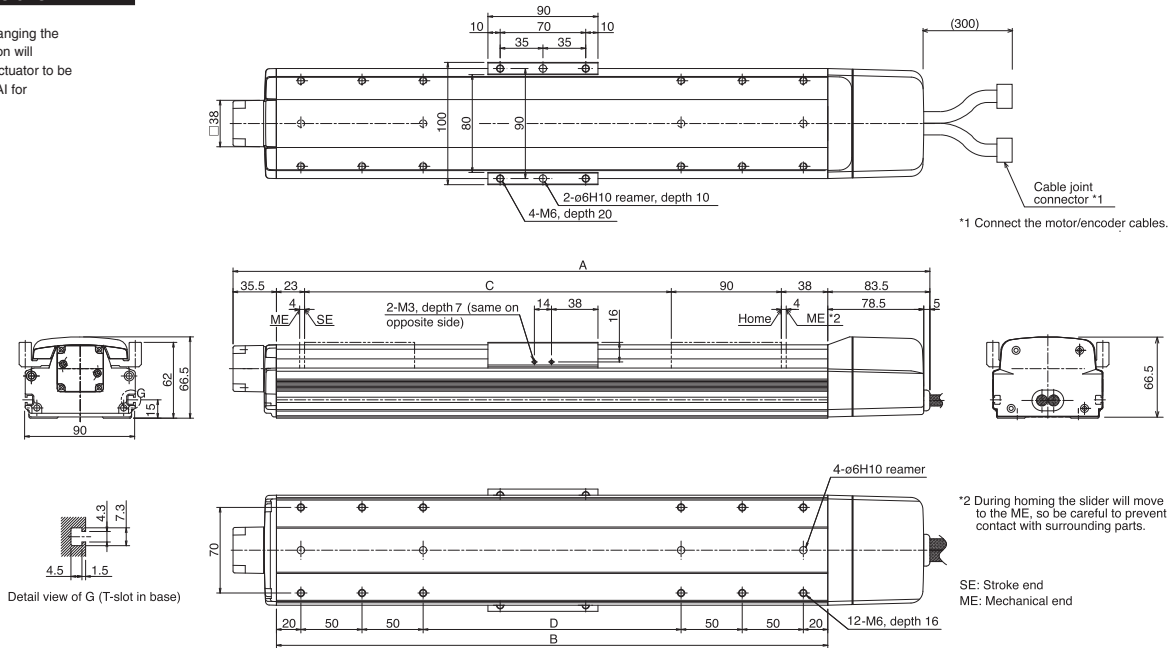

Dimensions, Weight and Maximum Speed by Stroke

Stroke	100	(150)	200	(250)	300	(350)	400	(450)	500	(550)	600	
A	370	420	470	520	570	620	670	720	770	820	870	
B	251	301	351	401	451	501	551	601	651	701	751	
C	100	150	200	250	300	350	400	450	500	550	600	
D	11	61	111	161	211	261	311	361	411	461	511	
Weight (kg)	3.0	3.4	3.7	4.1	4.4	4.8	5.1	5.5	5.8	6.2	6.5	
Maximum speed (mm/s)	Lead 8						400					
	Lead 4						200					

Applicable Controller Specifications

Applicable controller	Maximum number of controlled axes	Compatible encoder type	Program operation	Positioner operation	Pulse-train control	Supply voltage
X-SEL(-P/Q)	4(6) axes	Absolute/incremental	○	△		AC100/230V
S-SEL	2 axes	Absolute/incremental	○	△		AC100/230V
S-/E-CON	1 axis	Absolute/incremental		○/○	○/-	AC100/230V

*The SZM type comes standard with a brake, so use a controller of brake specification.

Caution

(Note 1) The strokes that are set in increments of 50 mm are semi-standard settings.
 (Note 2) Refer to page 38 for the relationship of acceleration and load capacity.
 (Notes 3, 4, 5) The figures in brackets apply to the ISPA Series.
 Other specification values apply to both the ISA and ISPA Series.
 (Note 6) The maximum cable length is 30 m. Specify the desired length in meters (e.g., X08 = 8 m).

* Refer to page 7 for other points to note.

ISA-MXM-100 Single-Axis Robot: Medium X-Axis Long Slider Type, Actuator Width 120mm, 100W, Straight Shape

ISPA-MXM-100 Single-Axis Robot: Medium X-Axis Long Slider Type, Actuator Width 120mm, 100W, Straight Shape **High-Precision Specification**

Type Medium X-axis (120-mm wide) long slider type Stroke 100 ~ 1000mm Load capacity 80kg (horizontal)/19kg (vertical)

Model specification items — Series Type Encoder type Motor output Lead Stroke Applicable controller Cable length Options
 ISA[ISPA] - MXM - A - 100 - 20 - 1000 - T1 - S - B



* Refer to page 9 for the details of model specification items.

Models/Specifications

Model	Encoder type	Motor output (W)	Lead (mm)	Stroke (mm) In increments of 50mm (Note 1)	Speed (Note 2) (mm/s)	Acceleration (Note 3)				Load capacity (Note 3)				Rated thrust (N)
						Horizontal (G)		Vertical (G)		Horizontal (kg)		Vertical (kg)		
						Rated	Maximum	Rated	Maximum	Rated	Maximum	Rated	Maximum	
ISA [ISPA] -MXM-A-100-20-***-T1(2)-△-□	Absolute	100	20	100 - 1000	1 ~ 1000	0.3	1.0	0.3	0.8	20	6	3.5	2	84.3
ISA [ISPA] -MXM-A-100-10-***-T1(2)-△-□			1 ~ 500		0.3	0.6	0.3	0.5	40	20	9	7	169.5	
ISA [ISPA] -MXM-A-100-5-***-T1(2)-△-□			1 ~ 250		0.15	0.5	0.15	0.3	80	45	19	15	340.1	
ISA [ISPA] -MXM-I-100-20-***-T1(2)-△-□	Incremental	100	20	100 - 1000	1 ~ 1000	0.3	1.0	0.3	0.8	20	6	3.5	2	84.3
ISA [ISPA] -MXM-I-100-10-***-T1(2)-△-□			1 ~ 500		0.3	0.6	0.3	0.5	40	20	9	7	169.5	
ISA [ISPA] -MXM-I-100-5-***-T1(2)-△-□			1 ~ 250		0.15	0.5	0.15	0.3	80	45	19	15	340.1	

* In the above model names, *** indicates the stroke, △ the cable length and □ the applicable options.

*1.0G=9800mm/sec²

Options

Name	Code	Page	Name	Code	Page
AQ seal	AQ	Ô P11	Master-axis designation	LM	Ô P12
Brake	B	Ô P11	Master-axis designation (sensor on opposite side)	LLM	Ô P12
Creep sensor	C	Ô P11	Reverse homing specification	NM	Ô P12
Creep sensor on opposite side	CL	Ô P11	Guide with ball-retaining mechanism	RT	Ô P12
Home limit switch	L	Ô P12	Slave-axis designation	S	Ô P12
Home limit switch on opposite side	LL	Ô P12	Metal cable joint connector	EU	→ P13

Common Specifications

* Refer to page 8 for the details of common specification items.

Positioning repeatability (Note 4)	±0.02mm [±0.01mm]
Drive system (Note 5)	Ball screw ø16mm, rolled C10 [equivalent to rolled C5]
Backlash (Note 6)	0.05mm or less [0.02mm or less]
Guide	Integrated with base
Allowable load moment	Ma: 69.6Nm Mb: 99.0Nm Mc: 161.7Nm
Overhung load length	Ma direction: 600mm or less, Mb/Mc directions: 600mm or less
Base	Material: Aluminum with white alumite treatment
Cable length (Note 7)	N: No cable, S: 3m, M: 5m, X□□ : Length specification

Dimensions

* Note that changing the home direction will require the actuator to be returned to IAI for adjustment.

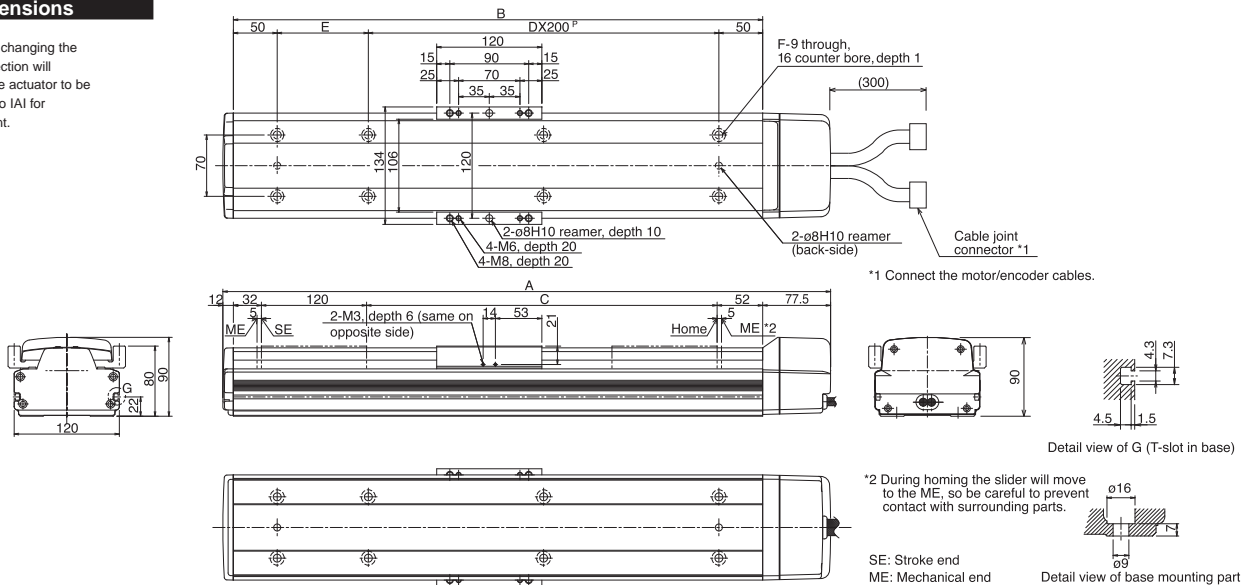

Dimensions, Weight and Maximum Speed by Stroke

Stroke	100	(150)	200	(250)	300	(350)	400	(450)	500	(550)	600	(650)	700	(750)	800	(850)	900	(950)	1000	
A	393.5	443.5	493.5	543.5	593.5	643.5	693.5	743.5	793.5	843.5	893.5	943.5	993.5	1043.5	1093.5	1143.5	1193.5	1243.5	1293.5	
B	304	354	404	454	504	554	604	654	704	754	804	854	904	954	1004	1054	1104	1154	1204	
C	100	150	200	250	300	350	400	450	500	550	600	650	700	750	800	850	900	950	1000	
D	0	0	1	1	1	1	2	2	2	2	3	3	3	3	4	4	4	4	5	
E	204	254	104	154	204	254	104	154	204	254	104	154	204	254	104	154	204	254	104	
F	4	4	6	6	6	6	8	8	8	8	10	10	10	10	12	12	12	12	14	
Weight (kg)	6.2	6.7	7.2	7.7	8.3	8.8	9.3	9.8	10.4	10.9	11.4	11.9	12.5	13.0	13.5	14.0	14.6	15.1	15.6	
Maximum speed (mm/s)	Lead 20													1000	795			645	540	
	Lead 10													500	480	380			310	255
	Lead 5													250	220	175			145	120

Applicable Controller Specifications

Applicable controller	Maximum number of controlled axes	Compatible encoder type	Program operation	Positioner operation	Pulse-train control	Supply voltage
X-SEL(-P/Q)	4(6) axes	Absolute/incremental	I	S		AC100/230V
S-SEL	2 axes	Absolute/incremental	○	△		AC100/230V
S/E-CON	1 axis	Absolute/incremental		○/○	○/-	AC100/230V



(Note 1) The strokes that are set in increments of 50 mm are semi-standard settings.
 (Note 2) A longer stroke will result in a lower maximum speed to prevent the ball screw from reaching a dangerous speed. (Refer to the above table for the maximum speed at a given stroke.)
 (Note 3) Refer to page 38 for the relationship of acceleration and load capacity. (Notes 4, 5, 6) The figures in brackets apply to the ISPA Series.
 Other specification values apply to both the ISA and ISPA Series.
 (Note 7) The maximum cable length is 30 m. Specify the desired length in meters (e.g., X08 = 8 m).

* Refer to page 7 for other points to note.

ISA-MXM-200 Single-Axis Robot: Medium X-Axis Long Slider Type, Actuator Width 120mm, 200W, Straight Shape

ISPA-MXM-200 Single-Axis Robot: Medium X-Axis Long Slider Type, Actuator Width 120mm, 200W, Straight Shape High-Precision Specification

Type Medium X-axis (120-mm wide) long slider type Stroke 100 ~ 1000mm Load capacity 80kg (horizontal)/19kg (vertical)

Model specification items Series Type Encoder type Motor output Lead Stroke Applicable controller Cable length Options
 ISA[ISPA] - MXM - A - 200 - 30 - 1000 - T1 - S - B



* Refer to page 9 for the details of model specification items.

Models/Specifications

Model	Encoder type	Motor output (W)	Lead (mm)	Stroke (mm) In increments of 50mm (Note 1)	Speed (Note 2) (mm/s)	Acceleration (Note 3)				Load capacity (Note 3)				Rated thrust (N)
						Horizontal (G)		Vertical (G)		Horizontal (kg)		Vertical (kg)		
						Rated	Maximum	Rated	Maximum	Rated	Maximum	Rated	Maximum	
ISA [ISPA] -MXM-A-200-30-***-T1(2)-△□	Absolute	200	30	100 ~ 1000	1 ~ 1500	0.3	1.0	0.3	1.0	25	10	6	2	113
ISA [ISPA] -MXM-A-200-20-***-T1(2)-△□			20		1 ~ 1000	0.3	1.0	0.3	0.8	40	12	9	5	169.5
ISA [ISPA] -MXM-A-200-10-***-T1(2)-△□			10		1 ~ 500	0.3	0.6	0.3	0.5	80	40	19	15	340.1
ISA [ISPA] -MXM-I-200-30-***-T1(2)-△□	Incremental	200	30	100 ~ 1000	1 ~ 1500	0.3	1.0	0.3	1.0	25	10	6	2	113
ISA [ISPA] -MXM-I-200-20-***-T1(2)-△□			20		1 ~ 1000	0.3	1.0	0.3	0.8	40	12	9	5	169.5
ISA [ISPA] -MXM-I-200-10-***-T1(2)-△□			10		1 ~ 500	0.3	0.6	0.3	0.5	80	40	19	15	340.1

* In the above model names, *** indicates the stroke, △ the cable length and □ the applicable options.

*1.0G=9800mm/sec²

Options

Name	Code	Page	Name	Code	Page
AQ seal	AQ	→ P11	Master-axis designation	LM	→ P12
Brake	B	→ P11	Master-axis designation (sensor on opposite side)	LLM	→ P12
Creep sensor	C	→ P11	Reverse homing specification	NM	→ P12
Creep sensor on opposite side	CL	→ P11	Guide with ball-retaining mechanism	RT	→ P12
Home limit switch	L	→ P12	Slave-axis designation	S	→ P12
Home limit switch on opposite side	LL	→ P12	Metal cable joint connector	EU	→ P13

Common Specifications

* Refer to page 8 for the details of common specification items.

Positioning repeatability (Note 4)	0.02mm [0.01mm]		
Drive system (Note 5)	Ball screw ø16mm, rolled C10 [equivalent to rolled C5]		
Backlash (Note 6)	0.05mm or less [0.02mm or less]		
Guide	Integrated with base		
Allowable load moment	Ma: 69.6Nm	Mb: 99.0Nm	Mc: 161.7Nm
Overhung load length	Ma direction: 600mm or less, Mb/Mc directions: 600mm or less		
Base	Material: Aluminum with white alumite treatment		
Cable length (Note 7)	N: No cable, S: 3m, M: 5m, X□□ : Length specification		

Dimensions

* Note that changing the home direction will require the actuator to be returned to IAI for adjustment.

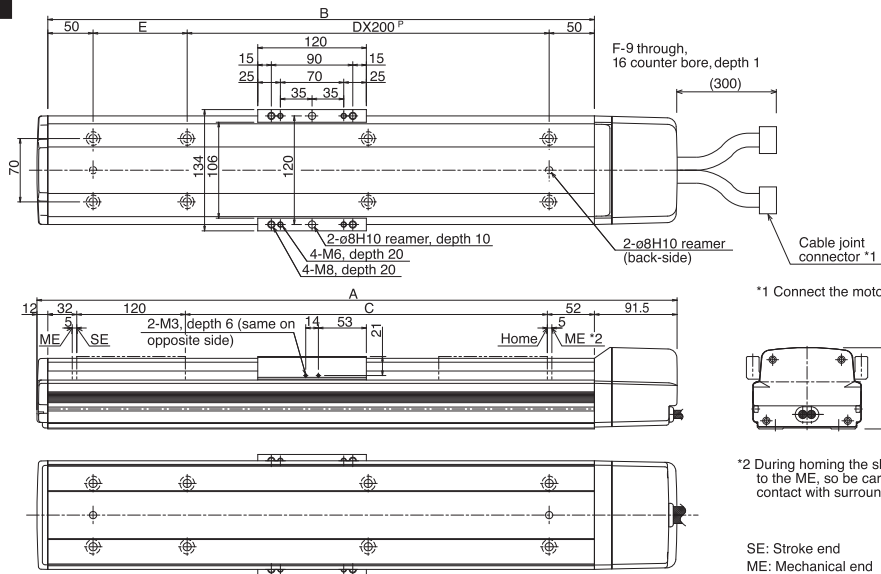

*1 Connect the motor/encoder cables.

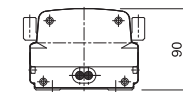

*2 During homing the slider will move to the ME, so be careful to prevent contact with surrounding parts.

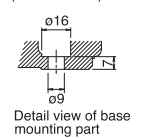
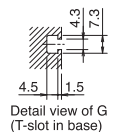

SE: Stroke end
ME: Mechanical end

Dimensions, Weight and Maximum Speed by Stroke

Stroke	100	(150)	200	(250)	300	(350)	400	(450)	500	(550)	600	(650)	700	(750)	800	(850)	900	(950)	1000
A	407.5	457.5	507.5	557.5	607.5	657.5	707.5	757.5	807.5	857.5	907.5	957.5	1007.5	1057.5	1107.5	1157.5	1207.5	1257.5	1307.5
B	304	354	404	454	504	554	604	654	704	754	804	854	904	954	1004	1054	1104	1154	1204
C	100	150	200	250	300	350	400	450	500	550	600	650	700	750	800	850	900	950	1000
D	0	0	1	1	1	1	2	2	2	2	3	3	3	3	4	4	4	4	5
E	204	254	104	154	204	254	104	154	204	254	104	154	204	254	104	154	204	254	104
F	4	4	6	6	6	6	8	8	8	8	10	10	10	10	12	12	12	12	14
Weight (kg)	6.6	7.1	7.6	8.1	8.7	9.2	9.7	10.2	10.8	11.3	11.8	12.3	12.9	13.4	13.9	14.4	15.0	15.5	16.0
Maximum speed (mm/s)	Lead 30	1500											1500	1190	965	810			
	Lead 20	1000											1000	795	645	540			
	Lead 10	500											480	380	310	255			

Applicable Controller Specifications

Applicable controller	Maximum number of controlled axes	Compatible encoder type	Program operation	Positioner operation	Pulse-train control	Supply voltage
X-SEL(-P/Q)	4(6) axes	Absolute/incremental	○	△		AC100/230V
S-SEL	2 axes	Absolute/incremental	○	△		AC100/230V
S/E-CON	1 axis	Absolute/incremental		○/○	○/-	AC100/230V

Caution
 (Note 1) The strokes that are set in increments of 50 mm are semi-standard settings.
 (Note 2) A longer stroke will result in a lower maximum speed to prevent the ball screw from reaching a dangerous speed. (Refer to the above table for the maximum speed at a given stroke.)
 (Note 3) Refer to page 38 for the relationship of acceleration and load capacity. (Notes 4, 5, 6) The figures in brackets apply to the ISPA Series.
 Other specification values apply to both the ISA and ISPA Series.
 (Note 7) The maximum cable length is 30 m. Specify the desired length in meters (e.g., X08 = 8 m).

* Refer to page 7 for other points to note.

ISA-MXXM Single-Axis Robot: Medium X-Axis Mid-Support Type, Actuator Width 120mm, 200W, Straight Shape

ISPA-MXXM Single-Axis Robot: Medium X-Axis Mid-Support Type, Actuator Width 120mm, 200W, Straight Shape **High-Precision Specification**

Type Medium X-axis (120-mm wide) mid-support type Stroke 800 ~ 2000mm Load capacity 40kg (horizontal)

Model specification items Series Type Encoder type Motor output Lead Stroke Applicable controller Cable length Options
 ISA[ISPA] - MXXM - A - 200 - 30 - 2000 - T1 - S - NM

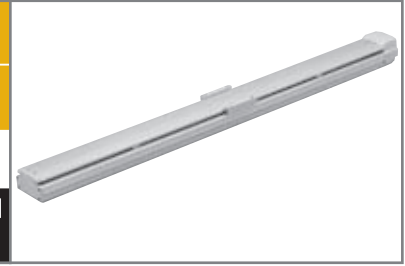

* Refer to page 9 for the details of model specification items.

Models/Specifications

Model	Encoder type	Motor output (W)	Lead (mm)	Stroke (mm) In increments of 10mm	Speed (Note 1) (mm/s)	Acceleration (Note 2)				Load capacity (Note 2)				Rated thrust (N)
						Horizontal (G)		Vertical (G)		Horizontal (kg)		Vertical (kg)		
						Rated	Maximum	Rated	Maximum	Rated	Maximum	Rated	Maximum	
ISA [ISPA] -MXXM-A-200-30-***-T1(2)-△□	Absolute	200	30	800 ~ 2000	1 ~ 1500	0.3	Horizontal application only	25	40	Horizontal application only	113			
ISA [ISPA] -MXXM-A-200-20-***-T1(2)-△□			20		1 ~ 1000	0.3						25	40	169.5
ISA [ISPA] -MXXM-I-200-30-***-T1(2)-△□	Incremental	200	30	800 ~ 2000	1 ~ 1500	0.3	Horizontal application only	25	40	Horizontal application only	113			
ISA [ISPA] -MXXM-I-200-20-***-T1(2)-△□			20		1 ~ 1000	0.3						25	40	169.5

* In the above model names, *** indicates the stroke, △ the cable length and □ the applicable options.

*1.0G=9800mm/sec²

Options

Name	Code	Page	Name	Code	Page
AQ seal	AQ	→ P11	Master-axis designation	LM	→ P12
Brake	B	→ P11	Master-axis designation (sensor on opposite side)	LLM	→ P12
Creep sensor	C	→ P11	Reverse homing specification	NM	→ P12
Creep sensor on opposite side	CL	→ P11	Guide with ball-retaining mechanism	RT	→ P12
Home limit switch	L	→ P12	Slave-axis designation	S	→ P12
Home limit switch on opposite side	LL	→ P12	Metal cable joint connector	EU	→ P13

Common Specifications

* Refer to page 8 for the details of common specification items.

Positioning repeatability (Note 3)	± 0.02mm [±0.01mm]
Drive system (Note 4)	Ball screw ø16mm, rolled C10 [equivalent to rolled C5]
Backlash (Note 5)	0.05mm or less [0.02mm or less]
Guide	Integrated with base
Allowable load moment	Ma: 69.6Nm Mb: 99.0Nm Mc: 161.7Nm
Overhung load length	Ma direction: 600mm or less, Mb/Mc directions: 600mm or less
Base	Material: Aluminum with white alumite treatment
Cable length (Note 6)	N: No cable, S: 3m, M: 5m, X□□□ : Length specification

Dimensions

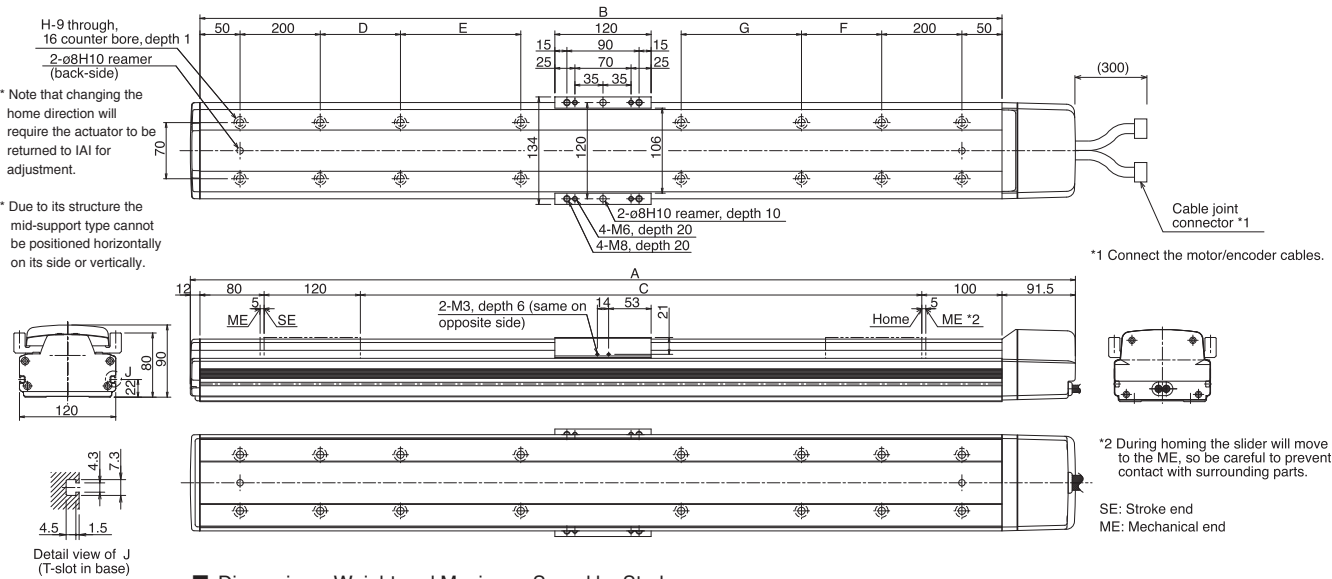

Dimensions, Weight and Maximum Speed by Stroke

Stroke	800	900	1000	1100	1200	1300	1400	1500	1600	1700	1800	1900	2000
A	1203.5	1303.5	1403.5	1503.5	1603.5	1703.5	1803.5	1903.5	2003.5	2103.5	2203.5	2303.5	2403.5
B	1100	1200	1300	1400	1500	1600	1700	1800	1900	2000	2100	2200	2300
C	800	900	1000	1100	1200	1300	1400	1500	1600	1700	1800	1900	2000
D	0	0	200	250	300	350	400	450	500	550	200	200	200
E	0	0	0	0	0	0	0	0	0	0	400	450	500
F	200	200	200	250	300	350	400	450	500	550	200	200	200
G	0	0	0	0	0	0	0	0	0	0	400	450	500
H	10	10	12	12	12	12	12	12	12	12	16	16	16
Weight (kg)	15.0	16.1	17.1	18.2	19.2	20.3	21.3	22.4	23.4	24.5	25.5	26.6	27.6
Maximum speed (mm/s)	Lead 30						1425	1200	1050	900	825	750	675
	Lead 20						950	800	700	600	550	500	450

Applicable Controller Specifications

Applicable controller	Maximum number of controlled axes	Compatible encoder type	Program operation	Positioner operation	Pulse-train control	Supply voltage
X-SEL(-P/Q)	4(6) axes	Absolute/incremental	○	△		AC100/230V
S-SEL	2 axes	Absolute/incremental	○	△		AC100/230V
S-/E-CON	1 axis	Absolute/incremental		○/○	○/○	AC100/230V



(Note 1) The strokes that are set in increments of 50 mm are semi-standard settings.
 (Note 2) Refer to page 38 for the relationship of acceleration and load capacity.
 (Notes 3, 4, 5) The figures in brackets apply to the ISPA Series.
 Other specification values apply to both the ISA and ISPA Series.
 (Note 6) The maximum cable length is 30 m. Specify the desired length in meters (e.g., X08 = 8 m).

* Refer to page 7 for other points to note.

ISA-MYM-100 Single-Axis Robot: Medium Y-Axis Long Slider Type, Actuator Width 120mm, 100W, Straight Shape

ISPA-MYM-100 Single-Axis Robot: Medium Y-Axis Long Slider Type, Actuator Width 120mm, 100W, Straight Shape **High-Precision Specification**

Type Medium Y-axis (120-mm wide) long slider type Stroke 100 ~ 1000mm Load capacity 80kg (horizontal)/19kg (vertical)

Model specification items Series Type Encoder type Motor output Lead Stroke Applicable controller Cable length Options

ISA[ISPA] - MYM - A - 100 - 20 - 1000 - T1 - S - NM

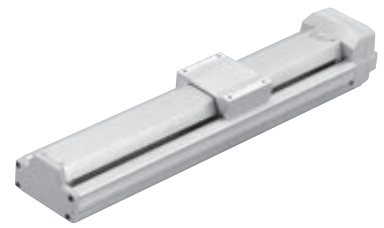

* Refer to page 9 for the details of model specification items.

Models/Specifications

Model	Encoder type	Motor output (W)	Lead (mm)	Stroke (mm) In increments of 50mm (Note 1)	Speed (Note 2) (mm/s)	Acceleration (Note 3)				Load capacity (Note 3)				Rated thrust (N)
						Horizontal (G)		Vertical (G)		Horizontal (kg)		Vertical (kg)		
						Rated	Maximum	Rated	Maximum	Rated acceleration	Maximum acceleration	Rated acceleration	Maximum acceleration	
ISA [ISPA] -MYM-A-100-20-***-T1(2)-△□	Absolute	100	20	100 ~ 1000	1 ~ 1000	0.3	1.0	0.3	0.8	20	6	3.5	2	84.3
ISA [ISPA] -MYM-A-100-10-***-T1(2)-△□			10		1 ~ 500	0.3	0.6	0.3	0.5	40	20	9	7	169.5
ISA [ISPA] -MYM-A-100-5-***-T1(2)-△□			5		1 ~ 250	0.15	0.5	0.15	0.3	80	45	19	15	340.1
ISA [ISPA] -MYM-I-100-20-***-T1(2)-△□	Incremental	100	20	100 ~ 1000	1 ~ 1000	0.3	1.0	0.3	0.8	20	6	3.5	2	84.3
ISA [ISPA] -MYM-I-100-10-***-T1(2)-△□			10		1 ~ 500	0.3	0.6	0.3	0.5	40	20	9	7	169.5
ISA [ISPA] -MYM-I-100-5-***-T1(2)-△□			5		1 ~ 250	0.15	0.5	0.15	0.3	80	45	19	15	340.1

* In the above model names, *** indicates the stroke, △ the cable length and □ the applicable options.

*1.0G=9800mm/sec²

Options

Name	Code	Page	Name	Code	Page
AQ seal	AQ	→ P11	Master-axis designation	LM	→ P12
Brake	B	→ P11	Master-axis designation (sensor on opposite side)	LLM	→ P12
Creep sensor	C	→ P11	Reverse homing specification	NM	→ P12
Creep sensor on opposite side	CL	→ P11	Guide with ball-retaining mechanism	RT	→ P12
Home limit switch	L	→ P12	Slave-axis designation	S	→ P12
Home limit switch on opposite side	LL	→ P12	Metal cable joint connector	EU	→ P13

Common Specifications

* Refer to page 8 for the details of common specification items.

Positioning repeatability (Note 4)	0.02mm [0.01mm]		
Drive system (Note 5)	Ball screw ø16mm, rolled C10 [equivalent to rolled C5]		
Backlash (Note 6)	0.05mm or less [0.02mm or less]		
Guide	Integrated with base		
Allowable load moment	Ma: 69.6N m	Mb: 99.0N m	Mc: 81.3N m
Overhung load length	Ma direction: 600mm or less, Mb/Mc directions: 600mm or less		
Base	Material: Aluminum with white alumite treatment		
Cable length (Note 7)	N: No cable, S: 3m, M: 5m, X□□ : Length specification		

Dimensions

* Note that changing the home direction will require the actuator to be returned to IAI for adjustment.

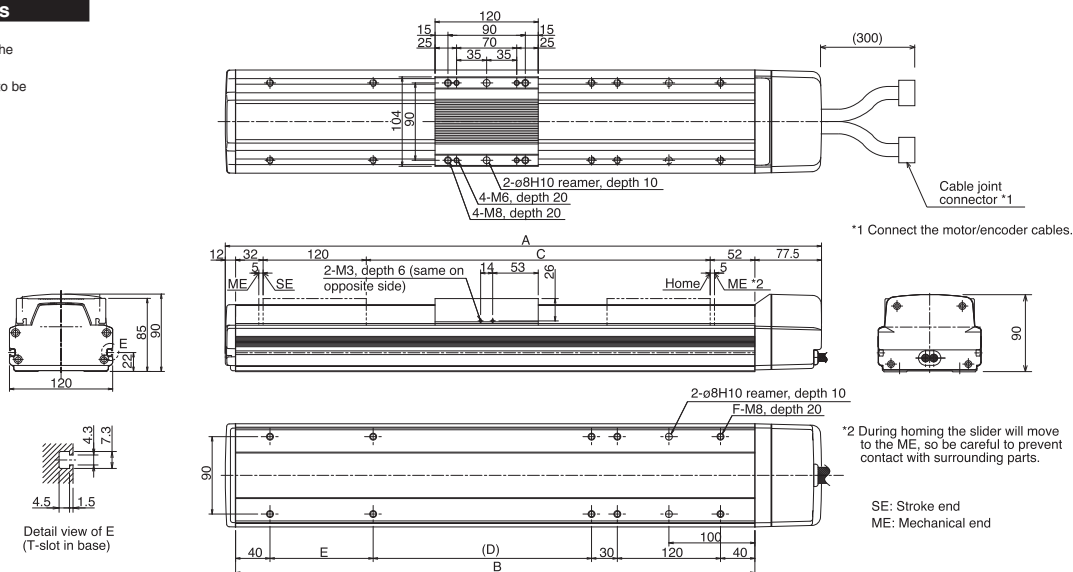

Dimensions, Weight and Maximum Speed by Stroke

Stroke	100	(150)	200	(250)	300	(350)	400	(450)	500	(550)	600	(650)	700	(750)	800	(850)	900	(950)	1000
A	393.5	443.5	493.5	543.5	593.5	643.5	693.5	743.5	793.5	843.5	893.5	943.5	993.5	1043.5	1093.5	1143.5	1193.5	1243.5	1293.5
B	304	354	404	454	504	554	604	654	704	754	804	854	904	954	1004	1054	1104	1154	1204
C	100	150	200	250	300	350	400	450	500	550	600	650	700	750	800	850	900	950	1000
D	∅	∅	54	104	154	204	254	304	354	404	454	504	554	604	654	704	754	804	854
E	120	∅	120	120	120	120	120	120	120	120	120	120	120	120	120	120	120	120	120
F	10	8	10	10	10	10	10	10	10	10	10	10	10	10	10	10	10	10	10
Weight (kg)	6.3	6.8	7.3	7.8	8.3	8.8	9.3	9.9	10.4	10.9	11.4	11.9	12.4	12.9	13.4	13.9	14.4	14.9	15.4
Maximum speed (mm/s)	Lead 20	1000																	
	Lead 10	500																	
	Lead 5	250																	

Applicable Controller Specifications

Applicable controller	Maximum number of controlled axes	Compatible encoder type	Program operation	Positioner operation	Pulse-train control	Supply voltage
X-SEL(-P/Q)	4(6) axes	Absolute/incremental	○	△		AC100/230V
S-SEL	2 axes	Absolute/incremental	○	△		AC100/230V
S-/E-CON	1 axis	Absolute/incremental		○/○	○/ -	AC100/230V



(Note 1) The strokes that are set in increments of 50 mm are semi-standard settings.
 (Note 2) A longer stroke will result in a lower maximum speed to prevent the ball screw from reaching a dangerous speed. (Refer to the above table for the maximum speed at a given stroke.)
 (Note 3) Refer to page 38 for the relationship of acceleration and load capacity. (Notes 4, 5, 6) The figures in brackets apply to the ISPA Series.
 Other specification values apply to both the ISA and ISPA Series.
 (Note 7) The maximum cable length is 30 m. Specify the desired length in meters (e.g., X08 = 8 m).

* Refer to page 7 for other points to note.

ISA-MYM-200 Single-Axis Robot: Medium Y-Axis Long Slider Type, Actuator Width 120mm, 200W, Straight Shape

ISPA-MYM-200 Single-Axis Robot: Medium Y-Axis Long Slider Type, Actuator Width 120mm, 200W, Straight Shape **High-Precision Specification**

Type Medium Y-axis (120-mm wide) long slider type Stroke 100 ~ 1000mm Load capacity 80kg (horizontal)/19kg (vertical)

n Model specification items — Series — Type — Encoder type — Motor output — Lead — Stroke — Applicable controller — Cable length — Options

ISA[ISPA] - MYM - A - 200 - 30 - 1000 - T1 - S - NM

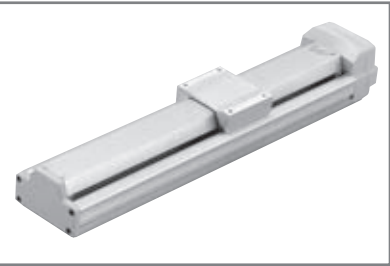

* Refer to page 9 for the details of model specification items.

Models/Specifications

Model	Encoder type	Motor output (W)	Lead (mm)	Stroke (mm) In increments of 50mm (Note 1)	Speed (Note 2) (mm/s)	Acceleration (Note 3)				Load capacity (Note 3)				Rated thrust (N)
						Horizontal (G)		Vertical (G)		Horizontal (kg)		Vertical (kg)		
						Rated	Maximum	Rated	Maximum	Rated (acceleration)	Maximum (acceleration)	Rated (acceleration)	Maximum (acceleration)	
ISA [ISPA] -MYM-A- 200-30- ***-T1(2)-△-□	Absolute	200	30	100 ~ 1000	1 ~ 1500	0.3	1.0	0.3	1.0	25	10	6	2	113
ISA [ISPA] -MYM-A- 200-20- ***-T1(2)-△-□			20		1 ~ 1000	0.3	1.0	0.3	0.8	40	12	9	5	169.5
ISA [ISPA] -MYM-A- 200-10- ***-T1(2)-△-□			10		1 ~ 500	0.3	0.6	0.3	0.5	80	40	19	15	340.1
ISA [ISPA] -MYM-I- 200-30- ***-T1(2)-△-□	Incremental	200	30	100 ~ 1000	1 ~ 1500	0.3	1.0	0.3	1.0	25	10	6	2	113
ISA [ISPA] -MYM-I- 200-20- ***-T1(2)-△-□			20		1 ~ 1000	0.3	1.0	0.3	0.8	40	12	9	5	169.5
ISA [ISPA] -MYM-I- 200-10- ***-T1(2)-△-□			10		1 ~ 500	0.3	0.6	0.3	0.5	80	40	19	15	340.1

* In the above model names, *** indicates the stroke, △ the cable length and □ the applicable options.

*1.0G=9800mm/sec²

Options

Name	Code	Page	Name	Code	Page
AQ seal	AQ	Ô P11	Master-axis designation	LM	Ô P12
Brake	B	Ô P11	Master-axis designation (sensor on opposite side)	LLM	Ô P12
Creep sensor	C	Ô P11	Reverse homing specification	NM	Ô P12
Creep sensor on opposite side	CL	Ô P11	Guide with ball-retaining mechanism	RT	Ô P12
Home limit switch	L	Ô P12	Slave-axis designation	S	Ô P12
Home limit switch on opposite side	LL	Ô P12	Metal cable joint connector	EU	→ P13

Common Specifications

* Refer to page 8 for the details of common specification items.

Positioning repeatability (Note 4)	±0.02mm [±0.01mm]
Drive system (Note 5)	Ball screw ø16mm, rolled C10 [equivalent to rolled C5]
Backlash (Note 6)	0.05mm or less [0.02mm or less]
Guide	Integrated with base
Allowable load moment	Ma: 69.6Nm Mb: 99.0Nm Mc: 81.3Nm
Overhung load length	Ma direction: 600mm or less, Mb/Mc directions: 600mm or less
Base	Material: Aluminum with white alumine treatment
Cable length (Note 7)	N: No cable, S: 3m, M: 5m, X□□ : Length specification

Dimensions

* Note that changing the home direction will require the actuator to be returned to IAI for adjustment.

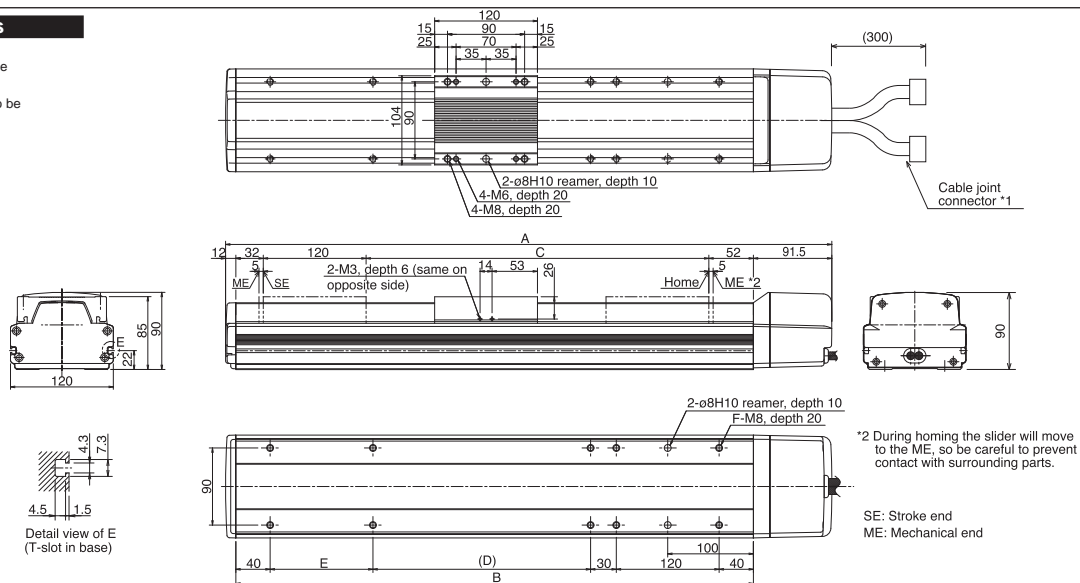

*2 During homing the slider will move to the ME, so be careful to prevent contact with surrounding parts.

n Dimensions, Weight and Maximum Speed by Stroke

Stroke	100	(150)	200	(250)	300	(350)	400	(450)	500	(550)	600	(650)	700	(750)	800	(850)	900	(950)	1000
A	407.5	457.5	507.5	557.5	607.5	657.5	707.5	757.5	807.5	857.5	907.5	957.5	1007.5	1057.5	1107.5	1157.5	1207.5	1257.5	1307.5
B	304	354	404	454	504	554	604	654	704	754	804	854	904	954	1004	1054	1104	1154	1204
C	100	150	200	250	300	350	400	450	500	550	600	650	700	750	800	850	900	950	1000
D	∅	∅	54	104	154	204	254	304	354	404	454	504	554	604	654	704	754	804	854
E	120	∅	120	120	120	120	120	120	120	120	120	120	120	120	120	120	120	120	120
F	10	8	10	10	10	10	10	10	10	10	10	10	10	10	10	10	10	10	10
Weight (kg)	6.8	7.3	7.8	8.3	8.8	9.3	9.8	10.4	10.9	11.4	11.9	12.4	12.9	13.4	13.9	14.4	14.9	15.4	15.9
Maximum speed (mm/s)	Lead 30	1500												1500	1190	965		810	
	Lead 20	1000												1000	795	645		540	
	Lead 10	500												480	380	310		255	

Applicable Controller Specifications

Applicable controller	Maximum number of controlled axes	Compatible encoder type	Program operation	Positioner operation	Pulse-train control	Supply voltage
X-SEL(-P/Q)	4(6) axes	Absolute/incremental		s		AC100/230V
S-SEL	2 axes	Absolute/incremental	○	△		AC100/230V
S-/E-CON	1 axis	Absolute/incremental		○/○	○/-	AC100/230V

Caution

(Note 1) The strokes that are set in increments of 50 mm are semi-standard settings.
 (Note 2) A longer stroke will result in a lower maximum speed to prevent the ball screw from reaching a dangerous speed. (Refer to the above table for the maximum speed at a given stroke.)
 (Note 3) Refer to page 38 for the relationship of acceleration and load capacity. (Notes 4, 5, 6) The figures in brackets apply to the ISPA Series.
 Other specification values apply to both the ISA and ISPA Series.
 (Note 7) The maximum cable length is 30 m. Specify the desired length in meters (e.g., X08 = 8 m).

* Refer to page 7 for other points to note.

ISA-MZM-100 Single-Axis Robot: Medium Vertical-Axis Long Slider Type, Actuator Width 120mm, 100W, Straight Shape

ISPA-MZM-100 Single-Axis Robot: Medium Vertical-Axis Long Slider Type, Actuator Width 120mm, 100W, Straight Shape **High-Precision Specification**

Type Medium vertical-axis (120-mm wide) long slider type Stroke 100 ~ 1000mm Vertical application only (with standard brake) 19kg

Model specification items Series Type Encoder type Motor output Lead Stroke Applicable controller Cable length Options
 ISA[ISPA] - MZM - A - 100 - 10 - 1000 - T1 - S - B - L

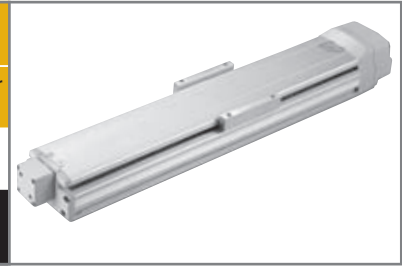

* Refer to page 9 for the details of model specification items.

Models/Specifications

Model	Encoder type	Motor output (W)	Lead (mm)	Stroke (mm) In increments of 50mm (Note 1)	Speed (Note 2) (mm/s)	Acceleration (Note 3)				Load capacity (Note 3)				Rated thrust (N)
						Horizontal (kg)		Vertical (kg)		Horizontal (kg)		Vertical (kg)		
						Rated	Maximum	Rated	Maximum	Rated	Maximum	Rated	Maximum	
ISA [ISPA] -MZM-A-100-10-***-T1(2)-△-B-□	Absolute	100	10	100 - 1000	1 ~ 500	Vertical application only		Vertical application only		9	7	169.5		
ISA [ISPA] -MZM-A-100-5-***-T1(2)-△-B-□			5		1 ~ 250	0.3	0.5	0.15	0.3	19	15	340.1		
ISA [ISPA] -MZM-I-100-10-***-T1(2)-△-B-□	Incremental	10	1 ~ 500		0.3	0.5	0.15	0.3	9	7	169.5			
ISA [ISPA] -MZM-I-100-5-***-T1(2)-△-B-□		5	1 ~ 250		0.15	0.3	0.15	0.3	19	15	340.1			

* In the above model names, *** indicates the stroke, △ the cable length and □ the applicable options.

*1.0G=9800mm/sec²

Options

Name	Code	Page	Name	Code	Page
AQ seal	AQ	→ P11	Master-axis designation	LM	→ P12
Brake	B	→ P11	Master-axis designation (sensor on opposite side)	LLM	→ P12
Creep sensor	C	→ P11	Reverse homing specification	NM	→ P12
Creep sensor on opposite side	CL	→ P11	Guide with ball-retaining mechanism	RT	→ P12
Home limit switch	L	→ P12	Slave-axis designation	S	→ P12
Home limit switch on opposite side	LL	→ P12	Metal cable joint connector	EU	→ P13

* The MZM type comes standard with a brake (B).

Common Specifications

* Refer to page 8 for the details of common specification items.

Positioning repeatability (Note 4)	±0.02mm [±0.01mm]		
Drive system (Note 5)	Ball screw ø16mm, rolled C10 [equivalent to rolled C5]		
Backlash (Note 6)	0.05mm or less [0.02mm or less]		
Guide	Integrated with base		
Allowable load moment	Ma: 69.6Nm	Mb: 99.0Nm	Mc: 81.3Nm
Brake	Comes standard with a dry, single-plate, non-excitation type electromagnetic brake.		
Base	Material: Aluminum with white alumite treatment		
Cable length (Note 7)	N: No cable, S: 3m, M: 5m, X□□ : Length specification		

Dimensions

* Note that changing the home direction will require the actuator to be returned to IA1 for adjustment.

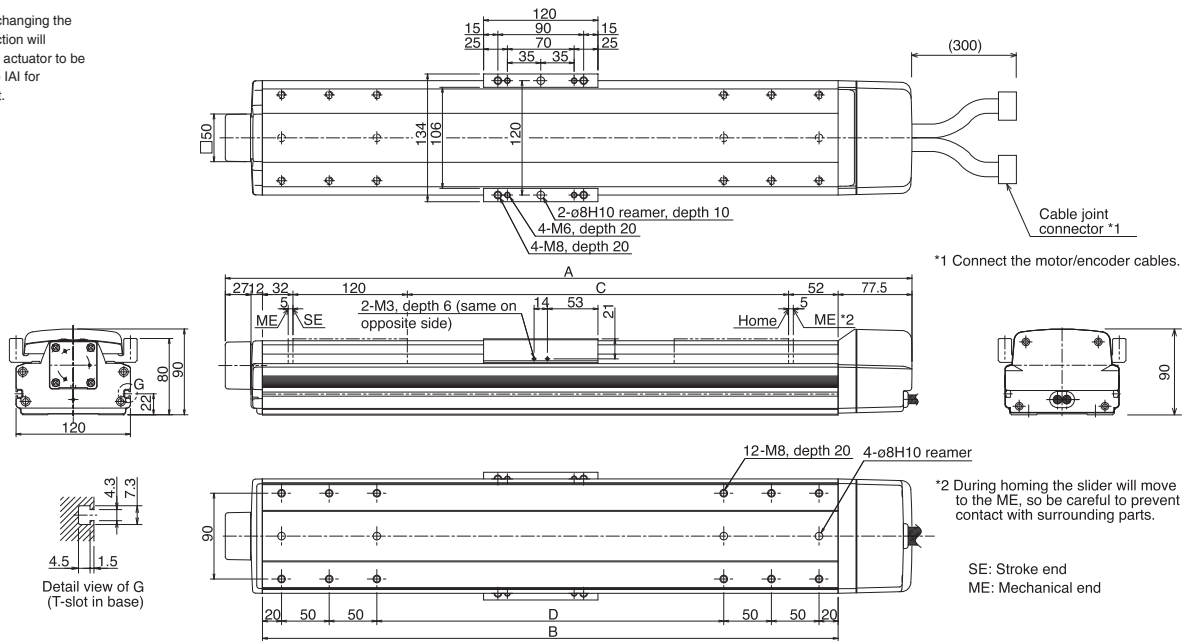

Dimensions, Weight and Maximum Speed by Stroke

Stroke	100	(150)	200	(250)	300	(350)	400	(450)	500	(550)	600	700	800	900	1000
A	420.5	470.5	520.5	570.5	620.5	670.5	720.5	770.5	820.5	870.5	920.5	Use the base of the MXM type for 700 and longer strokes. Refer to the drawing on page 16 for the mounting dimensions.			
B	304	354	404	454	504	554	604	654	704	754	804				
C	100	150	200	250	300	350	400	450	500	550	600				
D	64	114	164	214	264	314	364	414	464	514	564				
Weight (kg)	7.1	7.6	8.1	8.6	9.1	9.6	10.1	10.7	11.2	11.7	12.2	13.2	14.2	15.2	16.2
Maximum speed (mm/s)	Lead 10											480	380	310	255
	Lead 5											220	175	145	120

Applicable Controller Specifications

Applicable controller	Maximum number of controlled axes	Compatible encoder type	Program operation	Positioner operation	Pulse-train control	Supply voltage
X-SEL(-P/Q)	4(6) axes	Absolute/incremental	○	△		AC100/230V
S-SEL	2 axes	Absolute/incremental	○	△		AC100/230V
S/-E-CON	1 axis	Absolute/incremental		○ / ○	○ / -	AC100/230V

Caution

(Note 1) The strokes that are set in increments of 50 mm are semi-standard settings.
 (Note 2) A longer stroke will result in a lower maximum speed to prevent the ball screw from reaching a dangerous speed. (Refer to the above table for the maximum speed at a given stroke.)
 (Note 3) Refer to page 38 for the relationship of acceleration and load capacity. (Notes 4, 5, 6) The figures in brackets apply to the ISPA Series.
 Other specification values apply to both the ISA and ISPA Series.
 (Note 7) The maximum cable length is 30 m. Specify the desired length in meters (e.g., X08 = 8 m).

* The MZM type comes standard with a brake, so use a controller of brake specification.

* Refer to page 7 for other points to note.

ISA-MZM-200 Single-Axis Robot: Medium Vertical-Axis Long Slider Type, Actuator Width 120mm, 200W, Straight Shape
ISPA-MZM-200 Single-Axis Robot: Medium Vertical-Axis Long Slider Type, Actuator Width 120mm, 200W, Straight Shape High-Precision Specification

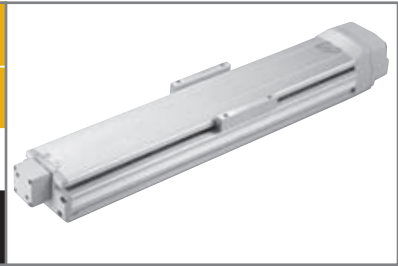

Type Medium vertical-axis (120-mm wide) long slider type Stroke 100 ~ 1000mm Vertical application only (with standard brake) 19kg

Model specification items Series Type Encoder type Motor output Lead Stroke Applicable controller Cable length Options
 ISA[ISPA] - MZM - A - 200 - 10 - 1000 - T1 - S - B - L

* Refer to page 9 for the details of model specification items.

Models/Specifications

Model	Encoder type	Motor output (W)	Lead (mm)	Stroke (mm) In increments of 50mm (Note 1)	Speed (Note 2) (mm/s)	Acceleration (Note 3)				Load capacity (Note 3)		Rated thrust (N)	
						Horizontal (G)		Vertical (G)		Horizontal (kg)	Vertical (kg)		
						Rated	Maximum	Rated	Maximum	Rated acceleration	Maximum acceleration		
ISA [ISPA]-MZM-A-200-10-***-T1(2)-△-B-□	Absolute	200	10	100 ~ 1000	1 ~ 500	Vertical application only		0.3	0.5	Vertical application only	19	15	340.1
ISA [ISPA]-MZM-I-200-10-***-T1(2)-△-B-□	Incremental				1 ~ 500	0.3	0.5	19	15	340.1			

* In the above model names, *** indicates the stroke, △ the cable length and □ the applicable options.

*1.0G=9800mm/sec²

Options

Name	Code	Page	Name	Code	Page
AQ seal	AQ	→ P11	Master-axis designation	LM	→ P12
Brake	B	→ P11	Master-axis designation (sensor on opposite side)	LLM	→ P12
Creep sensor	C	→ P11	Reverse homing specification	NM	→ P12
Creep sensor on opposite side	CL	→ P11	Guide with ball-retaining mechanism	RT	→ P12
Home limit switch	L	→ P12	Slave-axis designation	S	→ P12
Home limit switch on opposite side	LL	→ P12	Metal cable joint connector	EU	→ P13

* The MZM type comes standard with a brake (B).

Common Specifications

* Refer to page 8 for the details of common specification items.

Positioning repeatability (Note 4)	±0.02mm [±0.01mm]
Drive system (Note 5)	Ball screw ø16mm, rolled C10 [equivalent to rolled C5]
Backlash (Note 6)	0.05mm or less [0.02mm or less]
Guide	Integrated with base
Allowable load moment	Ma: 69.6Nm Mb: 99.0Nm Mc: 81.3Nm
Brake	Comes standard with a dry, single-plate, non-excitation type electromagnetic brake.
Base	Material: Aluminum with white alumite treatment
Cable length (Note 7)	N: No cable, S: 3m, M: 5m, X□□ : Length specification

Dimensions

* Note that changing the home direction will require the actuator to be returned to IAI for adjustment.

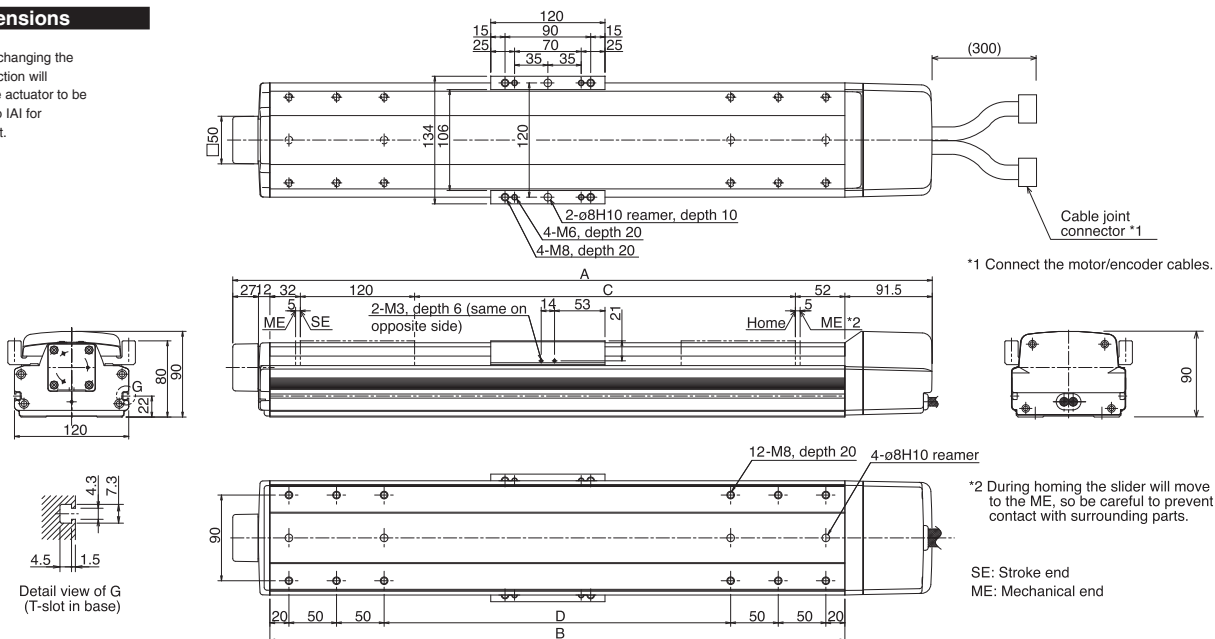

Dimensions, Weight and Maximum Speed by Stroke

Stroke	100	(150)	200	(250)	300	(350)	400	(450)	500	(550)	600	700	800	900	1000
A	434.5	484.5	534.5	584.5	634.5	684.5	734.5	784.5	834.5	884.5	934.5	Use the base of the MXM type for 700 and longer strokes. Refer to the drawing on page 17 for the mounting dimensions.			
B	304	354	404	454	504	554	604	654	704	754	804				
C	100	150	200	250	300	350	400	450	500	550	600				
D	64	114	164	214	264	314	364	414	464	514	564				
Weight (kg)	7.1	7.6	8.1	8.6	9.1	9.6	10.1	10.7	11.2	11.7	12.2	13.2	14.2	15.2	16.2
Maximum speed (mm/s)	500														

Applicable Controller Specifications

Applicable controller	Maximum number of controlled axes	Compatible encoder type	Program operation	Positioner operation	Pulse-train control	Supply voltage
X-SEL(-P/Q)	4(6) axes	Absolute/incremental	○	△		AC100/230V
S-SEL	2 axes	Absolute/incremental	○	△		AC100/230V
S/-E-CON	1 axis	Absolute/incremental		○/○	○/-	AC100/230V

* The MZM type comes standard with a brake, so use a controller of brake specification.

Caution

(Note 1) The strokes that are set in increments of 50 mm are semi-standard settings.
 (Note 2) A longer stroke will result in a lower maximum speed to prevent the ball screw from reaching a dangerous speed. (Refer to the above table for the maximum speed at a given stroke.)
 (Note 3) Refer to page 38 for the relationship of acceleration and load capacity. (Notes 4, 5, 6) The figures in brackets apply to the ISPA Series.
 Other specification values apply to both the ISA and ISPA Series.
 (Note 7) The maximum cable length is 30 m. Specify the desired length in meters (e.g., X08 = 8 m).

* Refer to page 7 for other points to note.

ISA-LXM-200 Single-Axis Robot: Large X-Axis Long Slider Type, Actuator Width 150mm, 200W, Straight Shape

ISPA-LXM-200 Single-Axis Robot: Large X-Axis Long Slider Type, Actuator Width 150mm, 200W, Straight Shape **High-Precision Specification**

Type Large X-axis (150-mm wide) long slider type Stroke 100 ~ 1200mm Load capacity 80kg (horizontal)/19kg (vertical)

Model specification items Series Type Encoder type Motor output Lead Stroke Applicable controller Cable length Options

ISA[ISPA] - LXM - A - 200 - 10 - 1200 - T1 - S - B



* Refer to page 9 for the details of model specification items.

Models/Specifications

Model	Encoder type	Motor output (W)	Lead (mm)	Stroke (mm) In increments of 50mm (Note 1)	Speed (Note 2) (mm/s)	Acceleration (Note 3)				Load capacity (Note 3)				Rated thrust (N)
						Horizontal (G)		Vertical (G)		Horizontal (kg)		Vertical (kg)		
						Rated	Maximum	Rated	Maximum	Rated acceleration	Maximum acceleration	Rated acceleration	Maximum acceleration	
ISA [ISPA] -LXM-A-200-20-***-T1(2)-△□	Absolute	200	20	100 ~ 1200	1 ~ 1000	0.3	1.0	0.3	0.8	40	12	9	4	170.5
ISA [ISPA] -LXM-A-200-10-***-T1(2)-△□			1 ~ 500		0.3	0.6	0.3	0.5	80	40	19	14	340.1	
ISA [ISPA] -LXM-I-200-20-***-T1(2)-△□	Incremental	200	20	100 ~ 1200	1 ~ 1000	0.3	1.0	0.3	0.8	40	12	9	4	170.5
ISA [ISPA] -LXM-I-200-10-***-T1(2)-△□			1 ~ 500		0.3	0.6	0.3	0.5	80	40	19	14	340.1	

* In the above model names, *** indicates the stroke, △ the cable length and □ the applicable options.

*1.0G=9800mm/sec²

Options

Name	Code	Page	Name	Code	Page
AQ seal	AQ	→ P11	Master-axis designation	LM	→ P12
Brake	B	→ P11	Master-axis designation (sensor on opposite side)	LLM	→ P12
Creep sensor	C	→ P11	Reverse homing specification	NM	→ P12
Creep sensor on opposite side	CL	→ P11	Guide with ball-retaining mechanism	RT	→ P12
Home limit switch	L	→ P12	Slave-axis designation	S	→ P12
Home limit switch on opposite side	LL	→ P12	Metal cable joint connector	EU	→ P13

Common Specifications

* Refer to page 8 for the details of common specification items.

Positioning repeatability (Note 4)	0.02mm [0.01mm]
Drive system (Note 5)	Ball screw ø20mm, rolled C10 [equivalent to rolled C5]
Backlash (Note 6)	0.05mm or less [0.02mm or less]
Guide	Integrated with base
Allowable load moment	Ma: 104.9Nm Mb: 149.9Nm Mc: 248.9Nm
Overhung load length	Ma direction: 750mm or less, Mb/Mc directions: 750mm or less
Base	Material: Aluminum with white alumite treatment
Cable length (Note 7)	N: No cable, S: 3m, M: 5m, X□□ : Length specification

Dimensions

* Note that changing the home direction will require the actuator to be returned to IAI for adjustment.

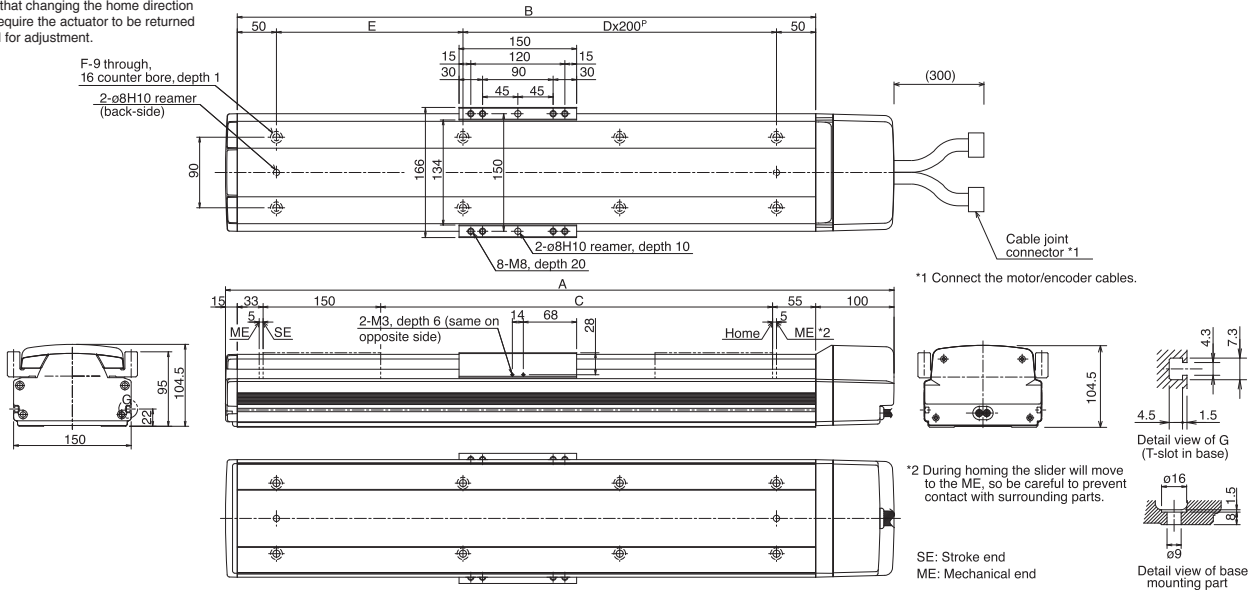

Dimensions, Weight and Maximum Speed by Stroke

Stroke	100	(150)	200	(250)	300	(350)	400	(450)	500	(550)	600	(650)	700	(750)	800	(850)	900	(950)	1000	(1050)	1100	(1150)	1200	
A	453	503	553	603	653	703	753	803	853	903	953	1003	1053	1103	1153	1203	1253	1303	1353	1403	1453	1503	1553	
B	338	388	438	488	538	588	638	688	738	788	838	888	938	988	1038	1088	1138	1188	1238	1288	1338	1388	1438	
C	100	150	200	250	300	350	400	450	500	550	600	650	700	750	800	850	900	950	1000	1050	1100	1150	1200	
D	0	0	1	1	1	1	2	2	2	3	3	3	3	3	4	4	4	4	5	5	5	5	6	
E	238	288	138	188	238	288	138	188	238	288	138	188	238	288	138	188	238	288	138	188	238	288	138	
F	4	4	6	6	6	6	8	8	8	8	10	10	10	10	10	12	12	12	12	14	14	14	16	
Weight (kg)	11.0	11.8	12.5	13.3	14.0	14.8	15.5	16.3	17.0	17.8	18.5	19.3	20.0	20.8	21.5	22.3	23.0	23.8	24.5	25.3	26.0	26.8	27.5	
Maximum speed (mm/s)	Lead 20															1000	830	690						500
	Lead 10															500	470	385	320					

Applicable Controller Specifications

Applicable controller	Maximum number of controlled axes	Compatible encoder type	Program operation	Positioner operation	Pulse-train control	Supply voltage
X-SEL(-P/Q)	4(6) axes	Absolute/incremental	○	△		AC100/230V
S-SEL	2 axes	Absolute/incremental	○	△		AC100/230V
S-/E-CON	1 axis	Absolute/incremental		○/○	○/-	AC100/230V



(Note 1) The strokes that are set in increments of 50 mm are semi-standard settings.
 (Note 2) A longer stroke will result in a lower maximum speed to prevent the ball screw from reaching a dangerous speed. (Refer to the above table for the maximum speed at a given stroke.)
 (Note 3) Refer to page 38 for the relationship of acceleration and load capacity.
 (Notes 4, 5, 6) The figures in brackets apply to the ISPA Series.
 Other specification values apply to both the ISA and ISPA Series.
 (Note 7) The maximum cable length is 30 m. Specify the desired length in meters (e.g., X08 = 8 m).

* Refer to page 7 for other points to note.

ISA-LXM-400 Single-Axis Robot: Large X-Axis Long Slider Type, Actuator Width 150mm, 400W, Straight Shape

ISPA-LXM-400 Single-Axis Robot: Large X-Axis Long Slider Type, Actuator Width 150mm, 400W, Straight Shape **High-Precision Specification**

Type Large X-axis (150-mm wide) long slider type Stroke 100 ~ 1200mm Load capacity 80kg (horizontal)/19kg (vertical)

n Model specification items Series Type Encoder type Motor output Lead Stroke Applicable controller Cable length Options

ISA[ISPA] - LXM - A - 400 - 40 - 1200 - T1 - S - B



* Refer to page 9 for the details of model specification items.

Models/Specifications

Model	Encoder type	Motor output (W)	Lead (mm)	Stroke (mm) In increments of 50mm (Note 1)	Speed (Note 2) (mm/s)	Acceleration (Note 3)				Load capacity (Note 3)				Rated thrust (N)
						Horizontal (G)		Vertical (G)		Horizontal (kg)		Vertical (kg)		
						Rated	Maximum	Rated	Maximum	Rated acceleration	Maximum acceleration	Rated acceleration	Maximum acceleration	
ISA [ISPA] -LXM-A-400-40-***-T1(2)-△□	Absolute	400	40	100 ~ 1200	1 ~ 2000	0.3	1.0	0.3	1.0	40	15	9	4	170.0
ISA [ISPA] -LXM-A-400-20-***-T1(2)-△□			20		1 ~ 1000	0.3	1.0	0.3	0.8	80	24	19	10	340.1
ISA [ISPA] -LXM-I-400-40-***-T1(2)-△□	Incremental	400	40	100 ~ 1200	1 ~ 2000	0.3	1.0	0.3	1.0	40	15	9	4	170.0
ISA [ISPA] -LXM-I-400-20-***-T1(2)-△□			20		1 ~ 1000	0.3	1.0	0.3	0.8	80	24	19	10	340.1

* In the above model names, *** indicates the stroke, △ the cable length and □ the applicable options.

*1.0G=9800mm/sec²

Options

Name	Code	Page	Name	Code	Page
AQ seal	AQ	Ô P11	Master-axis designation	LM	Ô P12
Brake	B	Ô P11	Master-axis designation (sensor on opposite side)	LLM	Ô P12
Creep sensor	C	Ô P11	Reverse homing specification	NM	Ô P12
Creep sensor on opposite side	CL	Ô P11	Guide with ball-retaining mechanism	RT	Ô P12
Home limit switch	L	Ô P12	Slave-axis designation	S	Ô P12
Home limit switch on opposite side	LL	Ô P12	Metal cable joint connector	EU	→ P13

Common Specifications

* Refer to page 8 for the details of common specification items.

Positioning repeatability (Note 4)	±0.02mm [±0.01mm]
Drive system (Note 5)	Ball screw ø20mm, rolled C10 [equivalent to rolled C5]
Backlash (Note 6)	0.05mm or less [0.02mm or less]
Guide	Integrated with base
Allowable load moment	Ma: 104.7Nm Mb: 149.9Nm Mc: 248.9Nm
Overhung load length	Ma direction: 750mm or less, Mb/Mc directions: 750mm or less
Base	Material: Aluminum with white alumite treatment
Cable length (Note 7)	N: No cable, S: 3m, M: 5m, X □ □ : Length specification

Dimensions

* Note that changing the home direction will require the actuator to be returned to IAI for adjustment.

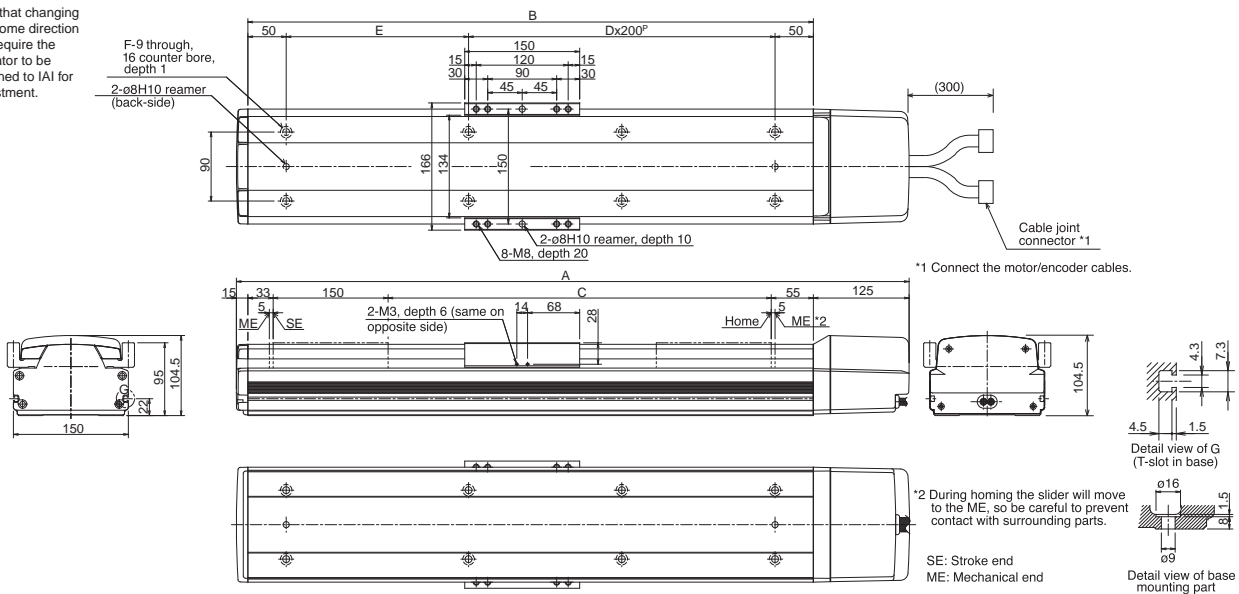

n Dimensions, Weight and Maximum Speed by Stroke

Stroke	100	(150)	200	(250)	300	(350)	400	(450)	500	(550)	600	(650)	700	(750)	800	(850)	900	(950)	1000	(1050)	1100	(1150)	1200				
A	478	528	578	628	678	728	778	828	878	928	978	1028	1078	1128	1178	1228	1278	1328	1378	1428	1478	1528	1578				
B	338	388	438	488	538	588	638	688	738	788	838	888	938	988	1038	1088	1138	1188	1238	1288	1338	1388	1438				
C	100	150	200	250	300	350	400	450	500	550	600	650	700	750	800	850	900	950	1000	1050	1100	1150	1200				
D	0	0	1	1	1	1	2	2	2	2	3	3	3	3	4	4	4	4	5	5	5	5	6				
E	238	288	138	188	238	288	138	188	238	288	138	188	238	288	138	188	238	288	138	188	238	288	138				
F	4	4	6	6	6	6	8	8	8	8	10	10	10	10	12	12	12	12	14	14	14	14	16				
Weight (kg)	12.0	12.8	13.5	14.3	15.0	15.8	16.5	17.3	18.0	18.8	19.5	20.3	21.0	21.8	22.5	23.3	24.0	24.8	25.5	26.3	27.0	27.8	28.5				
Maximum speed (mm/s)	Lead 40																	2000		1660		1380		1170		1000	
	Lead 20																	1000		830		690		585		500	

Applicable Controller Specifications

Applicable controller	Maximum number of controlled axes	Compatible encoder type	Program operation	Positioner operation	Pulse-train control	Supply voltage
X-SEL(-P/Q)	4(6) axes	Absolute/incremental	I	S		AC100/230V
S-SEL	2 axes	Absolute/incremental	O	△		AC100/230V
S/E-CON	1 axis	Absolute/incremental		○/○	○/-	AC100/230V

Caution

(Note 1) The strokes that are set in increments of 50 mm are semi-standard settings.
 (Note 2) A longer stroke will result in a lower maximum speed to prevent the ball screw from reaching a dangerous speed. (Refer to the above table for the maximum speed at a given stroke.)
 (Note 3) Refer to page 38 for the relationship of acceleration and load capacity. (Notes 4, 5, 6) The figures in brackets apply to the ISPA Series.
 Other specification values apply to both the ISA and ISPA Series.
 (Note 7) The maximum cable length is 30 m. Specify the desired length in meters (e.g., X08 = 8 m).

* Refer to page 7 for other points to note.

ISA-LXMX-200 Single-Axis Robot: Large X-Axis Mid-Support Type, Actuator Width 150mm, 200W, Straight Shape

ISPA-LXMX-200 Single-Axis Robot: Large X-Axis Mid-Support Type, Actuator Width 150mm, 200W, Straight Shape **High-Precision Specification**

Type: Large X-axis (150-mm wide) mid-support type | Stroke: 1000 ~ 2500mm | Load capacity: 40kg (horizontal)

Model specification items: Series - Type - Encoder type - Motor output - Lead - Stroke - Applicable controller - Cable length - Options
 ISA[ISPA] - LXMX - A - 200 - 20 - 2500 - T1 - S - NM

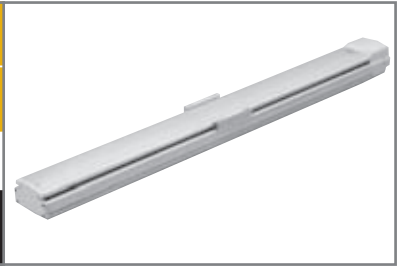

* Refer to page 9 for the details of model specification items.

Models/Specifications

Model	Encoder type	Motor output (W)	Lead (mm)	Stroke (mm) In increments of 100mm	Speed (Note 1) (mm/s)	Acceleration (Note 2)		Load capacity (Note 2)		Rated thrust (N)
						Horizontal (G)	Vertical (G)	Horizontal (kg)	Vertical (kg)	
ISA [ISPA] -LXMX-A-200-20-***-T1(2)-△□	Absolute	200	20	1000 ~ 2500	1 ~ 1000	Rated: 0.3	Maximum: 0.3	Horizontal application only	40	170.5
ISA [ISPA] -LXMX-I-200-20-***-T1(2)-△□	Incremental		20		1 ~ 1000	Rated: 0.3	Maximum: 0.3		Horizontal application only	

* In the above model names, *** indicates the stroke, △ the cable length and □ the applicable options.

*1.0G=9800mm/sec²

Options

Name	Code	Page	Name	Code	Page
AQ seal	AQ	→ P11	Master-axis designation	LM	→ P12
Brake	B	→ P11	Master-axis designation (sensor on opposite side)	LLM	→ P12
Creep sensor	C	→ P11	Reverse homing specification	NM	→ P12
Creep sensor on opposite side	CL	→ P11	Guide with ball-retaining mechanism	RT	→ P12
Home limit switch	L	→ P12	Slave-axis designation	S	→ P12
Home limit switch on opposite side	LL	→ P12	Metal cable joint connector	EU	→ P13

Common Specifications

* Refer to page 8 for the details of common specification items.

Positioning repeatability (Note 3)	0.02mm [0.01mm]		
Drive system (Note 4)	Ball screw ø20mm, rolled C10 [equivalent to rolled C5]		
Backlash (Note 5)	0.05mm or less [0.02mm or less]		
Guide	Integrated with base		
Allowable load moment	Ma: 104.9Nm	Mb: 149.9Nm	Mc: 248.9Nm
Overhung load length	Ma direction: 750mm or less, Mb/Mc directions: 750mm or less		
Base	Material: Aluminum with white alumite treatment		
Cable length (Note 6)	N: No cable, S: 3m, M: 5m, X□□ : Length specification		

Dimensions

* Note that changing the home direction will require the actuator to be returned to IAI for adjustment.

* Due to its structure the mid-support type cannot be positioned horizontally on its side or vertically.

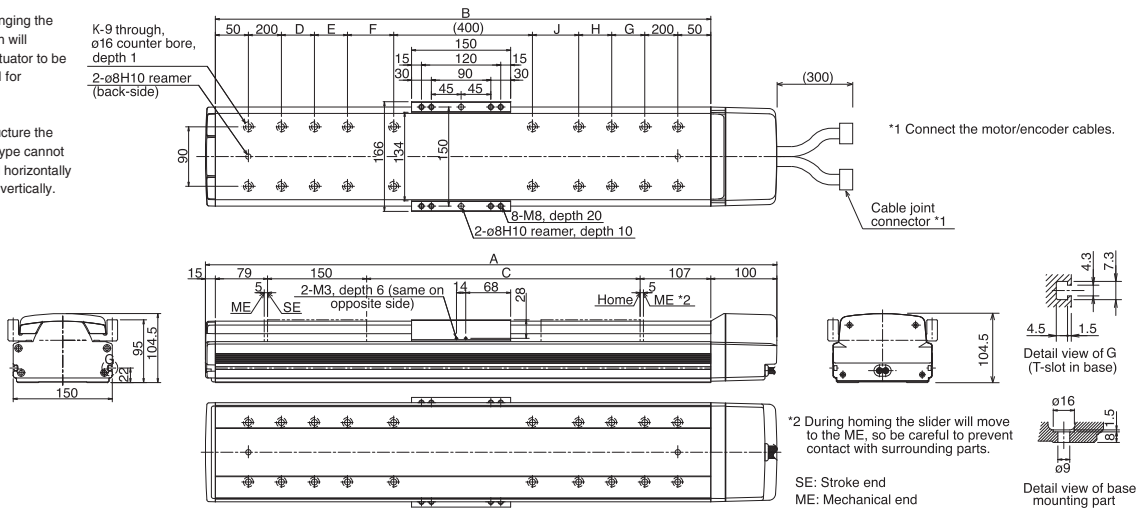

Dimensions, Weight and Maximum Speed by Stroke

Stroke	1000	1100	1200	1300	1400	1500	1600	1700	1800	1900	2000	2100	2200	2300	2400	2500	
A	1465	1565	1665	1765	1865	1965	2065	2165	2265	2365	2465	2565	2665	2765	2865	2965	
B	1350	1450	1550	1650	1750	1850	1950	2050	2150	2250	2350	2450	2550	2650	2750	2850	
C	1014	1114	1214	1314	1414	1514	1614	1714	1814	1914	2014	2114	2214	2314	2414	2514	
D	225	275	325	375	425	475	525	575	200	200	200	200	200	200	200	200	
E	0	0	0	0	0	0	0	0	425	475	525	575	200	200	200	200	
F	0	0	0	0	0	0	0	0	0	0	0	425	475	525	575	575	
G	225	275	325	375	425	475	525	575	200	200	200	200	200	200	200	200	
H	0	0	0	0	0	0	0	0	425	475	525	575	200	200	200	200	
J	0	0	0	0	0	0	0	0	0	0	0	425	475	525	575	575	
K	12	12	12	12	12	12	12	12	16	16	16	16	20	20	20	20	
Weight (kg)	27.5	29.0	30.5	32.0	33.5	35.0	36.5	38.0	39.5	41.0	42.5	44.0	45.5	47.0	48.5	50.0	
Maximum speed (mm/s)	1000						950	830	740	650	590	540	490	440	410	370	340

Applicable Controller Specifications

Applicable controller	Maximum number of controlled axes	Compatible encoder type	Program operation	Positioner operation	Pulse-train control	Supply voltage
X-SEL(-P/Q)	4(6) axes	Absolute/incremental	○	△		AC100/230V
S-SEL	2 axes	Absolute/incremental	○	△		AC100/230V
S-/E-CON	1 axis	Absolute/incremental		○/○	○/-	AC100/230V

Caution

(Note 1) The strokes that are set in increments of 50 mm are semi-standard settings.
 (Note 2) Refer to page 38 for the relationship of acceleration and load capacity.
 (Notes 3, 4, 5) The figures in brackets apply to the ISPA Series.
 Other specification values apply to both the ISA and ISPA Series.
 (Note 6) The maximum cable length is 30 m. Specify the desired length in meters (e.g., X08 = 8 m).

* Refer to page 7 for other points to note.

ISA-LXMX-400 Single-Axis Robot: Large X-Axis Mid-Support Type, Actuator Width 150mm, 400W, Straight Shape

ISPA-LXMX-400 Single-Axis Robot: Large X-Axis Mid-Support Type, Actuator Width 150mm, 400W, Straight Shape **High-Precision Specification**

Type	Large X-axis (150-mm wide) mid-support type	Stroke	1000 ~ 2500mm	Load capacity	80kg (horizontal)
------	---	--------	---------------	---------------	-------------------

n Model specification items — Series — Type — Encoder type — Motor output — Lead — Stroke — Applicable controller — Cable length — Options

ISA[ISPA] - LXMX - A - 400 - 40 - 2500 - T1 - S - NM



* Refer to page 9 for the details of model specification items.

Models/Specifications

Model	Encoder type	Motor output (W)	Lead (mm)	Stroke (mm) In increments of 100mm	Speed (Note 1) (mm/s)	Acceleration (Note 2)				Load capacity (Note 2)				Rated thrust (N)
						Horizontal (G)		Vertical (G)		Horizontal (kg)		Vertical (kg)		
						Rated	Maximum	Rated	Maximum	Rated	Maximum	Rated	Maximum	
ISA [ISPA] -LXMX-A-400-40-***-T1(2)-△□	Absolute	400	40	1000 - 2500	1 ~ 2000	0.3		Horizontal application only		40		Horizontal application only		170.0
ISA [ISPA] -LXMX-A-400-20-***-T1(2)-△□			20		1 ~ 1000	0.3		80		Horizontal application only		340.1		
ISA [ISPA] -LXMX-I-400-40-***-T1(2)-△□	Incremental	400	40	1000 - 2500	1 ~ 2000	0.3		Horizontal application only		40		Horizontal application only		170.0
ISA [ISPA] -LXMX-I-400-20-***-T1(2)-△□			20		1 ~ 1000	0.3		80		Horizontal application only		340.1		

* In the above model names, *** indicates the stroke, △ the cable length and □ the applicable options.

*1.0G=9800mm/sec²

Options

Name	Code	Page	Name	Code	Page
AQ seal	AQ	Ô P11	Master-axis designation	LM	Ô P12
Brake	B	Ô P11	Master-axis designation (sensor on opposite side)	LLM	Ô P12
Creep sensor	C	Ô P11	Reverse homing specification	NM	Ô P12
Creep sensor on opposite side	CL	Ô P11	Guide with ball-retaining mechanism	RT	Ô P12
Home limit switch	L	Ô P12	Slave-axis designation	S	Ô P12
Home limit switch on opposite side	LL	Ô P12			

Common Specifications

* Refer to page 8 for the details of common specification items.

Positioning repeatability (Note 3)	±0.02mm [±0.01mm]		
Drive system (Note 4)	Ball screw ø20mm, rolled C10 [equivalent to rolled C5]		
Backlash (Note 5)	0.05mm or less [0.02mm or less]		
Guide	Integrated with base		
Allowable load moment	Ma: 104.9Nm	Mb: 149.9Nm	Mc: 248.9Nm
Overhung load length	Ma direction: 750mm or less, Mb/Mc directions: 750mm or less		
Base	Material: Aluminum with white alumite treatment		
Cable length (Note 6)	N: No cable, S: 3m, M: 5m, X □ □ : Length specification		

Dimensions

* Note that changing the home direction will require the actuator to be returned to IAI for adjustment.

* Due to its structure the mid-support type cannot be positioned horizontally on its side or vertically.

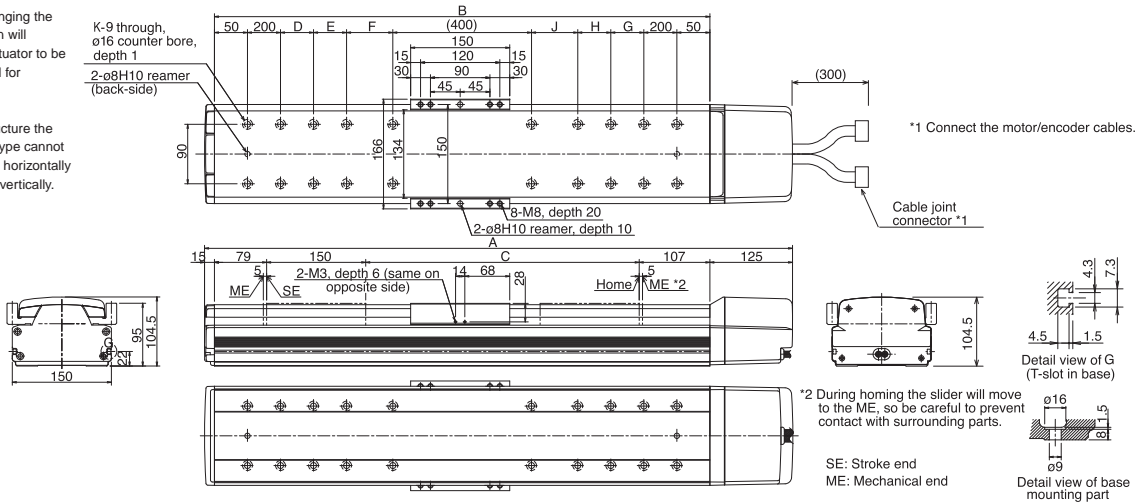

n Dimensions, Weight and Maximum Speed by Stroke

Stroke	1000	1100	1200	1300	1400	1500	1600	1700	1800	1900	2000	2100	2200	2300	2400	2500	
A	1490	1590	1690	1790	1890	1990	2090	2190	2290	2390	2490	2590	2690	2790	2890	2990	
B	1350	1450	1550	1650	1750	1850	1950	2050	2150	2250	2350	2450	2550	2650	2750	2850	
C	1014	1114	1214	1314	1414	1514	1614	1714	1814	1914	2014	2114	2214	2314	2414	2514	
D	225	275	325	375	425	475	525	575	200	200	200	200	200	200	200	200	
E	0	0	0	0	0	0	0	0	425	475	525	575	200	200	200	200	
F	0	0	0	0	0	0	0	0	0	0	0	425	475	525	575	575	
G	225	275	325	375	425	475	525	575	200	200	200	200	200	200	200	200	
H	0	0	0	0	0	0	0	0	425	475	525	575	200	200	200	200	
J	0	0	0	0	0	0	0	0	0	0	0	425	475	525	575	575	
K	12	12	12	12	12	12	12	12	16	16	16	20	20	20	20	20	
Weight (kg)	28.5	30.0	31.5	33.0	34.5	36.0	37.5	39.0	40.5	42.0	43.5	45.0	46.5	48.0	49.5	51.0	
Maximum speed (mm/s)	Lead 40	2000					1900	1660	1480	1300	1180	1080	980	880	820	740	680
	Lead 20	1000					950	830	740	650	590	540	490	440	410	370	340

Applicable Controller Specifications

Applicable controller	Maximum number of controlled axes	Compatible encoder type	Program operation	Positioner operation	Pulse-train control	Supply voltage
X-SEL(-P/Q)	4(6) axes	Absolute/incremental		s		AC100/230V
E-Con	1 axis	Absolute/incremental				AC100/230V
P-Driver	1 axis	Incremental				AC100/230V

Caution

(Note 1) The strokes that are set in increments of 50 mm are semi-standard settings.
 (Note 2) Refer to page 38 for the relationship of acceleration and load capacity.
 (Notes 3, 4, 5) The figures in brackets apply to the ISPA Series.
 Other specification values apply to both the ISA and ISPA Series.
 (Note 6) The maximum cable length is 30 m. Specify the desired length in meters (e.g., X08 = 8 m).

* Refer to page 7 for other points to note.

ISA-LXUWX-200 Single-Axis Robot: Large X-Axis Mid-Support, Double Slider Type, Actuator Width 150mm, 200W, Straight Shape

ISPA-LXUWX-200 Single-Axis Robot: Large X-Axis Mid-Support, Double Slider Type, Actuator Width 150mm, 200W, Straight Shape **High-Precision Specification**

Type Large X-axis (150-mm wide) mid-support, double slider type Stroke 1000 ~ 2500mm Load capacity 40kg (horizontal)

Model specification items Series Type Encoder type Motor output Lead Stroke Applicable controller Cable length Options

ISA[ISPA] - LXUMX - A - 200 - 20 - 2500 - T1 - S - NM

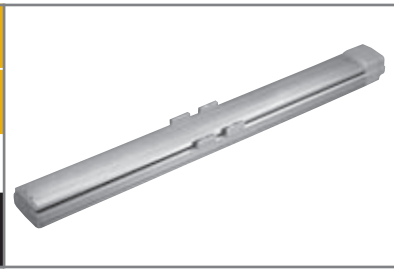

* Refer to page 9 for the details of model specification items.

Models/Specifications

Model	Encoder type	Motor output (W)	Lead (mm)	Stroke (mm) In increments of 100mm	Speed (Note 1) (mm/s)	Acceleration (Note 2)		Load capacity (Note 2)		Rated thrust (N)
						Horizontal (G)	Vertical (G)	Horizontal (kg)	Vertical (kg)	
ISA [ISPA] -LXUWX-A-200-20-***-T1(2)-△□	Absolute	200	20	1000 ~ 2500	1 ~ 1000	Rated	Maximum	Rated	Maximum	170.5
ISA [ISPA] -LXUWX-I-200-20-***-T1(2)-△□	Incremental		20			Horizontal application only	Horizontal application only	40	40	

* In the above model names, *** indicates the stroke, △ the cable length and □ the applicable options.

*1.0G=9800mm/sec²

Options

Name	Code	Page	Name	Code	Page
AQ seal	AQ	→ P11	Master-axis designation	LM	→ P12
Brake	B	→ P11	Master-axis designation (sensor on opposite side)	LLM	→ P12
Creep sensor	C	→ P11	Reverse homing specification	NM	→ P12
Creep sensor on opposite side	CL	→ P11	Guide with ball-retaining mechanism	RT	→ P12
Home limit switch	L	→ P12	Slave-axis designation	S	→ P12
Home limit switch on opposite side	LL	→ P12	Metal cable joint connector	EU	→ P13

Common Specifications

* Refer to page 8 for the details of common specification items.

Positioning repeatability (Note 3)	0.02mm [0.01mm]
Drive system (Note 4)	Ball screw ø20mm, rolled C10 [equivalent to rolled C5]
Backlash (Note 5)	0.05mm or less [0.02mm or less]
Guide	Integrated with base
Allowable load moment	Ma: 179.3N m Mb: 254.8N m Mc: 247.0N m
Overhung load length	Ma direction: 1250mm or less, Mb/Mc directions: 1250mm or less
Base	Material: Aluminum with white alumite treatment
Cable length (Note 6)	N: No cable, S: 3m, M: 5m, X□□ : Length specification

Dimensions

* Note that changing the home direction will require the actuator to be returned to |A| for adjustment.

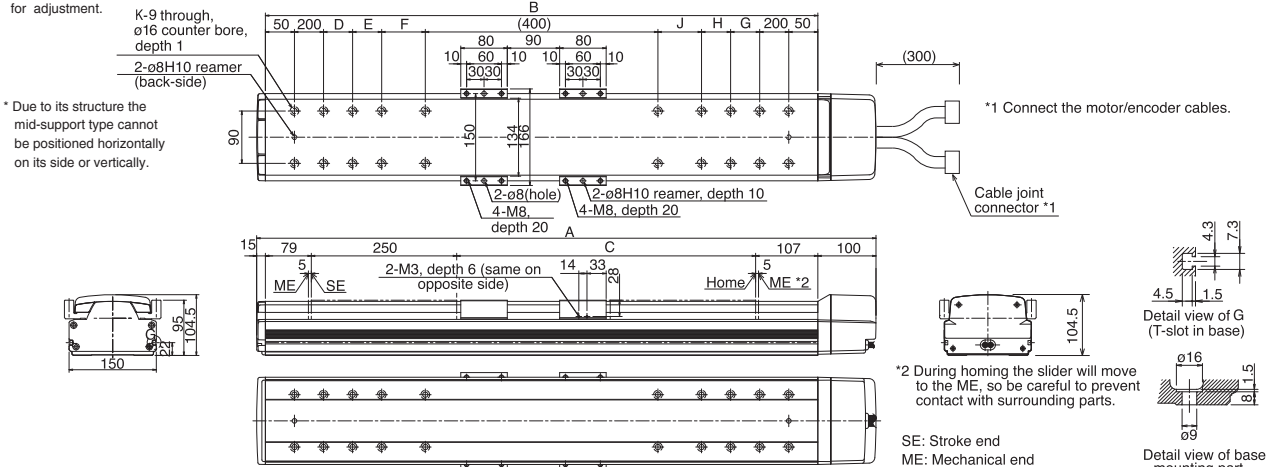

Dimensions, Weight and Maximum Speed by Stroke

Stroke	1000	1100	1200	1300	1400	1500	1600	1700	1800	1900	2000	2100	2200	2300	2400	2500
A	1565	1665	1765	1865	1965	2065	2165	2265	2365	2465	2565	2665	2765	2865	2965	3065
B	1450	1550	1650	1750	1850	1950	2050	2150	2250	2350	2450	2550	2650	2750	2850	2950
C	1014	1114	1214	1314	1414	1514	1614	1714	1814	1914	2014	2114	2214	2314	2414	2514
D	275	325	375	425	475	525	575	200	200	200	200	200	200	200	200	200
E	0	0	0	0	0	0	0	425	475	525	575	200	200	200	200	200
F	0	0	0	0	0	0	0	0	0	0	0	425	475	525	575	625
G	275	325	375	425	475	525	575	200	200	200	200	200	200	200	200	200
H	0	0	0	0	0	0	0	425	475	525	575	200	200	200	200	200
J	0	0	0	0	0	0	0	0	0	0	0	425	475	525	575	625
K	12	12	12	12	12	12	12	16	16	16	16	20	20	20	20	20
Weight (kg)	29.0	30.5	32.0	33.5	35.0	36.5	38.0	39.5	41.0	42.5	44.0	45.5	47.0	48.5	50.0	51.5
Maximum speed (mm/s)	1000					950	830	740	650	590	540	490	440	410	370	340

Applicable Controller Specifications

Applicable controller	Maximum number of controlled axes	Compatible encoder type	Program operation	Positioner operation	Pulse-train control	Supply voltage
X-SEL(-P/Q)	4(6) axes	Absolute/incremental	○	△		AC100/230V
S-SEL	2 axes	Absolute/incremental	○	△		AC100/230V
S-/E-CON	1 axis	Absolute/incremental		○/○	○/-	AC100/230V

Caution

(Note 1) The strokes that are set in increments of 50 mm are semi-standard settings.

(Note 2) Refer to page 38 for the relationship of acceleration and load capacity.

(Notes 3, 4, 5) The figures in brackets apply to the ISPA Series. Other specification values apply to both the ISA and ISPA Series.

(Note 6) The maximum cable length is 30 m. Specify the desired length in meters (e.g., X08 = 8 m).

* Refer to page 7 for other points to note.

ISA-LXUWX-400 Single-Axis Robot: Large X-Axis Mid-Support, Double Slider Type, Actuator Width 150mm, 400W, Straight Shape

ISPA-LXUWX-400 Single-Axis Robot: Large X-Axis Mid-Support, Double Slider Type, Actuator Width 150mm, 400W, Straight Shape High-Precision Specification

Type	Large X-axis (150-mm wide) mid-support, double slider type	Stroke	1000 ~ 2500mm	Load capacity	80kg (horizontal)
------	--	--------	---------------	---------------	-------------------

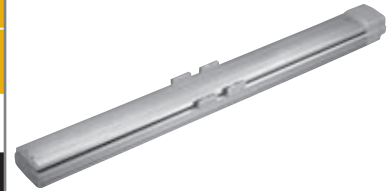

n Model specification items	Series	Type	Encoder type	Motor output	Lead	Stroke	Applicable controller	Cable length	Options
	ISA[ISPA]	- LXUWX - A	-	400	- 40	- 2500	- T1	S	- NM

* Refer to page 9 for the details of model specification items.

Models/Specifications

Model	Encoder type	Motor output (W)	Lead (mm)	Stroke (mm) In increments of 100mm	Speed (Note 1) (mm/s)	Acceleration (Note 2)				Load capacity (Note 2)		Rated thrust (N)
						Horizontal (G)		Vertical (G)		Horizontal (kg)	Vertical (kg)	
						Rated	Maximum	Rated	Maximum	Rated acceleration	Maximum acceleration	
ISA [ISPA] -LXUWX-A-400-40-***-T1(2)-△□	Absolute	400	40	1000 ~ 2500	1 ~ 2000	0.3	Horizontal application only	40	80	Horizontal application only	170.0	
ISA [ISPA] -LXUWX-A-400-20-***-T1(2)-△□			20		1 ~ 1000	0.3					340.1	
ISA [ISPA] -LXUWX-I-400-40-***-T1(2)-△□	Incremental	400	40	1000 ~ 2500	1 ~ 2000	0.3	Horizontal application only	40	80	Horizontal application only	170.0	
ISA [ISPA] -LXUWX-I-400-20-***-T1(2)-△□			20		1 ~ 1000	0.3					340.1	

* In the above model names, *** indicates the stroke, △ the cable length and □ the applicable options.

*1.0G=9800mm/sec²

Options

Name	Code	Page	Name	Code	Page
AQ seal	AQ	Ô P11	Master-axis designation	LM	Ô P12
Brake	B	Ô P11	Master-axis designation (sensor on opposite side)	LLM	Ô P12
Creep sensor	C	Ô P11	Reverse homing specification	NM	Ô P12
Creep sensor on opposite side	CL	Ô P11	Guide with ball-retaining mechanism	RT	Ô P12
Home limit switch	L	Ô P12	Slave-axis designation	S	Ô P12
Home limit switch on opposite side	LL	Ô P12	Metal cable joint connector	EU	→ P13

Common Specifications

* Refer to page 8 for the details of common specification items.

Positioning repeatability (Note 3)	±0.02mm [±0.01mm]		
Drive system (Note 4)	Ball screw ø20mm, rolled C10 [equivalent to rolled C5]		
Backlash (Note 5)	0.05mm or less [0.02mm or less]		
Guide	Integrated with base		
Allowable load moment	Ma: 179.3Nm	Mb: 254.8Nm	Mc: 247.0Nm
Overhung load length	Ma direction: 1250mm or less, Mb/Mc directions: 1250mm or less		
Base	Material: Aluminum with white alumite treatment		
Cable length (Note 6)	N: No cable, S: 3m, M: 5m, X □ □ : Length specification		

Dimensions

* Note that changing the home direction will require the actuator to be returned to IAI for adjustment.

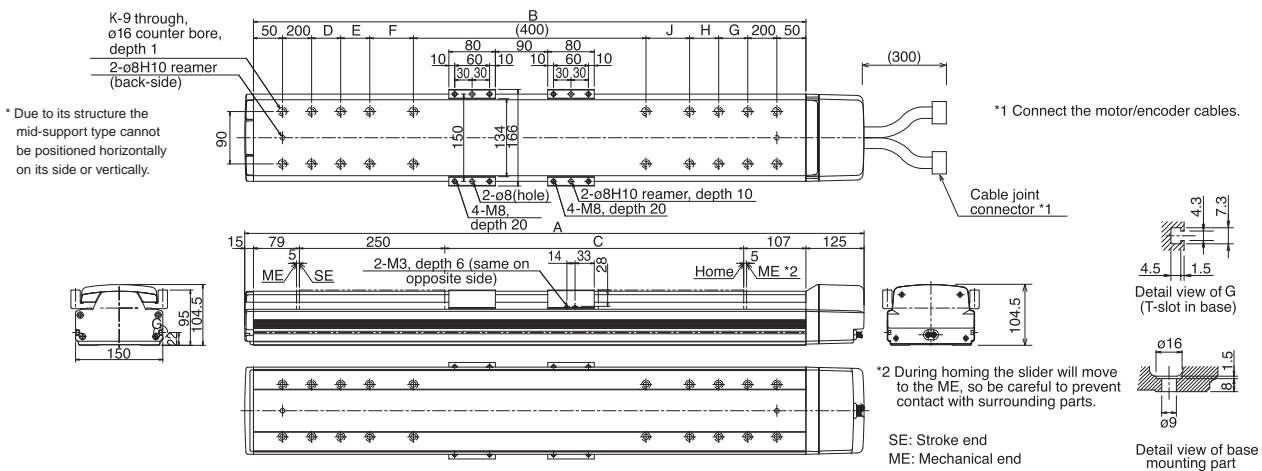

n Dimensions, Weight and Maximum Speed by Stroke

Stroke	1000	1100	1200	1300	1400	1500	1600	1700	1800	1900	2000	2100	2200	2300	2400	2500	
A	1590	1690	1790	1890	1990	2090	2190	2290	2390	2490	2590	2690	2790	2890	2990	3090	
B	1450	1550	1650	1750	1850	1950	2050	2150	2250	2350	2450	2550	2650	2750	2850	2950	
C	1014	1114	1214	1314	1414	1514	1614	1714	1814	1914	2014	2114	2214	2314	2414	2514	
D	275	325	375	425	475	525	575	200	200	200	200	200	200	200	200	200	
E	0	0	0	0	0	0	0	425	475	525	575	200	200	200	200	200	
F	0	0	0	0	0	0	0	0	0	0	0	425	475	525	575	625	
G	275	325	375	425	475	525	575	200	200	200	200	200	200	200	200	200	
H	0	0	0	0	0	0	0	425	475	525	575	200	200	200	200	200	
J	0	0	0	0	0	0	0	0	0	0	0	425	475	525	575	625	
K	12	12	12	12	12	12	12	16	16	16	16	20	20	20	20	20	
Weight (kg)	30.0	31.5	33.0	34.5	36.0	37.5	39.0	40.5	42.0	43.5	45.0	46.5	48.0	49.5	51.0	52.5	
Maximum speed (mm/s)	Lead 40	2000					1900	1660	1480	1300	1180	1080	980	880	820	740	680
	Lead 20	1000					950	830	740	650	590	540	490	440	410	370	340

Applicable Controller Specifications

Applicable controller	Maximum number of controlled axes	Compatible encoder type	Program operation	Positioner operation	Pulse-train control	Supply voltage
X-SEL(-P/Q)	4(6) axes	Absolute/incremental		s		AC100/230V
S-SEL	2 axes	Absolute/incremental	○	△		AC100/230V
S/E-CON	1 axis	Absolute/incremental		○/○	○/ -	AC100/230V



Caution

(Note 1) The strokes that are set in increments of 50 mm are semi-standard settings.
 (Note 2) Refer to page 38 for the relationship of acceleration and load capacity.
 (Notes 3, 4, 5) The figures in brackets apply to the ISPA Series.
 Other specification values apply to both the ISA and ISPA Series.
 (Note 6) The maximum cable length is 30 m. Specify the desired length in meters (e.g., X08 = 8 m).

* Refer to page 7 for other points to note.

ISA-LYM-200 Single-Axis Robot: Large Y-Axis Long Slider Type, Actuator Width 150mm, 200W, Straight Shape

ISPA-LYM-200 Single-Axis Robot: Large Y-Axis Long Slider Type, Actuator Width 150mm, 200W, Straight Shape **High-Precision Specification**

Type Large Y-axis (150-mm wide) long slider type Stroke 100 ~ 1200mm Load capacity 80kg (horizontal)/19kg (vertical)

Model specification items — Series — Type — Encoder type — Motor output — Lead — Stroke — Applicable controller — Cable length — Options

ISA[ISPA] - LYM - A - 200 - 20 - 1200 D T1 - S - NM

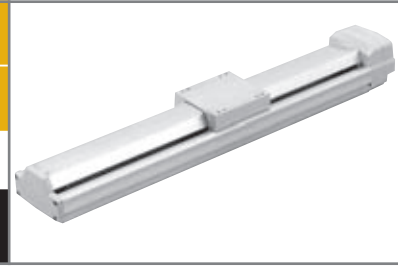

* Refer to page 9 for the details of model specification items.

Models/Specifications

Model	Encoder type	Motor output (W)	Lead (mm)	Stroke (mm) In increments of 50mm (Note 1)	Speed (Note 2) (mm/s)	Acceleration (Note 3)				Load capacity (Note 3)				Rated thrust (N)
						Horizontal (G)		Vertical (G)		Horizontal (kg)		Vertical (kg)		
						Rated	Maximum	Rated	Maximum	Rated acceleration	Maximum acceleration	Rated acceleration	Maximum acceleration	
ISA [ISPA] -LYM-A-200-20-***-T1(2)-△□	Absolute	200	20	100 ~ 1200	1 ~ 1000	0.3	1.0	0.3	0.8	40	12	9	4	170.5
ISA [ISPA] -LYM-A-200-10-***-T1(2)-△□			1 ~ 500		0.3	0.6	0.3	0.5	80	40	19	14	340.1	
ISA [ISPA] -LYM-I-200-20-***-T1(2)-△□	Incremental		20		1 ~ 1000	0.3	1.0	0.3	0.8	40	12	9	4	170.5
ISA [ISPA] -LYM-I-200-10-***-T1(2)-△□			10		1 ~ 500	0.3	0.6	0.3	0.5	80	40	19	14	340.1

* In the above model names, *** indicates the stroke, △ the cable length and □ the applicable options.

* 1.0G=9800mm/sec²

Options

Name	Code	Page	Name	Code	Page
AQ seal	AQ	→ P11	Master-axis designation	LM	→ P12
Brake	B	→ P11	Master-axis designation (sensor on opposite side)	LLM	→ P12
Creep sensor	C	→ P11	Reverse homing specification	NM	→ P12
Creep sensor on opposite side	CL	→ P11	Guide with ball-retaining mechanism	RT	→ P12
Home limit switch	L	→ P12	Slave-axis designation	S	→ P12
Home limit switch on opposite side	LL	→ P12	Metal cable joint connector	EU	→ P13

Common Specifications

* Refer to page 8 for the details of common specification items.

Positioning repeatability (Note 4)	0.02mm [0.01mm]
Drive system (Note 5)	Ball screw ø20mm, rolled C10 [equivalent to rolled C5]
Backlash (Note 6)	0.05mm or less [0.02mm or less]
Guide	Integrated with base
Allowable load moment	Ma: 104.9Nm Mb: 149.9Nm Mc: 124.5Nm
Overhung load length	Ma direction: 750mm or less, Mb/Mc directions: 750mm or less
Base	Material: Aluminum with white alumite treatment
Cable length (Note 7)	N: No cable, S: 3m, M: 5m, X□□ : Length specification

Dimensions

* Note that changing the home direction will require the actuator to be returned to IAI for adjustment.

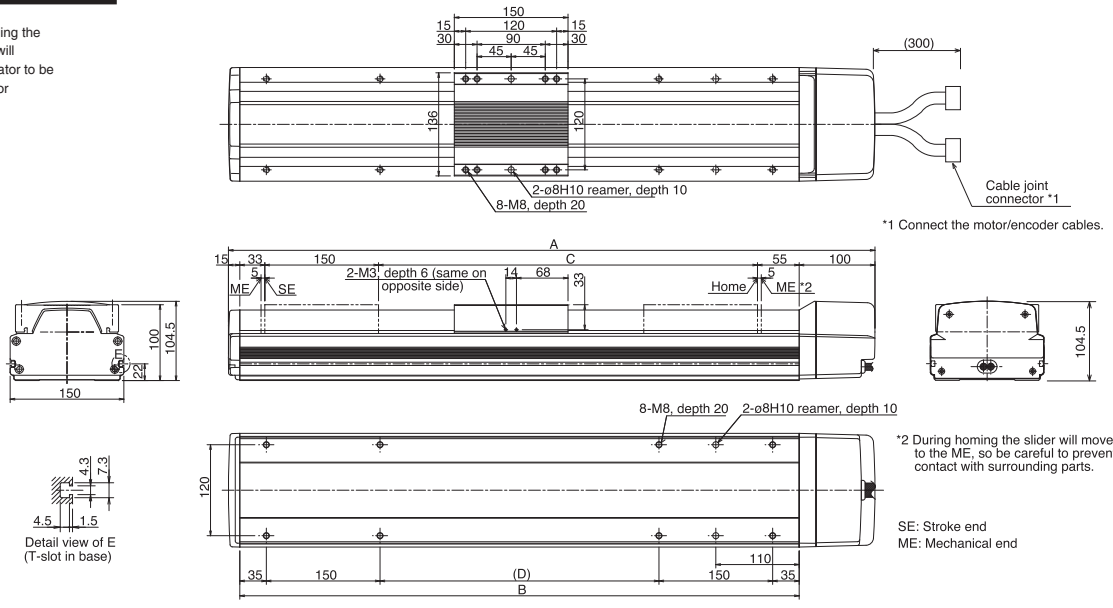

Dimensions, Weight and Maximum Speed by Stroke

Stroke	100	(150)	200	(250)	300	(350)	400	(450)	500	(550)	600	(650)	700	(750)	800	(850)	900	(950)	1000	(1050)	1100	(1150)	1200	
A	453	503	553	603	653	703	753	803	853	903	953	1003	1053	1103	1153	1203	1253	1303	1353	1403	1453	1503	1553	
B	338	388	438	488	538	588	638	688	738	788	838	888	938	988	1038	1088	1138	1188	1238	1288	1338	1388	1438	
C	100	150	200	250	300	350	400	450	500	550	600	650	700	750	800	850	900	950	1000	1050	1100	1150	1200	
D	0	0	1	1	1	1	2	2	2	2	3	3	3	3	4	4	4	4	5	5	5	5	6	
Weight (kg)	11.0	11.8	12.5	12.3	14.1	14.9	15.7	16.5	17.3	18.1	18.8	19.6	20.4	21.2	22.0	22.8	23.5	24.3	25.1	25.9	26.7	27.5	28.2	
Maximum speed (mm/s)	Lead 20															1000	830	690	585	500				
	Lead 10															500	470	385	320	270	235			

Applicable Controller Specifications

Applicable controller	Maximum number of controlled axes	Compatible encoder type	Program operation	Positioner operation	Pulse-train control	Supply voltage
X-SEL(-P/Q)	4(6) axes	Absolute/incremental	○	△		AC100/230V
S-SEL	2 axes	Absolute/incremental	○	△		AC100/230V
S/-E-COON	1 axis	Absolute/incremental		○/○	○/-	AC100/230V

Caution

(Note 1) The strokes that are set in increments of 50 mm are semi-standard settings.
 (Note 2) A longer stroke will result in a lower maximum speed to prevent the ball screw from reaching a dangerous speed. (Refer to the above table for the maximum speed at a given stroke.)
 (Note 3) Refer to page 38 for the relationship of acceleration and load capacity. (Notes 4, 5, 6) The figures in brackets apply to the ISPA Series.
 Other specification values apply to both the ISA and ISPA Series.
 (Note 7) The maximum cable length is 30 m. Specify the desired length in meters (e.g., X08 = 8 m).

* Refer to page 7 for other points to note.

ISA-LYM-400 Single-Axis Robot: Large Y-Axis Long Slider Type, Actuator
Width 150mm, 400W, Straight Shape

ISPA-LYM-400 Single-Axis Robot: Large Y-Axis Long Slider Type, Actuator
Width 150mm, 400W, Straight Shape **High-Precision Specification**

Type Large Y-axis (150-mm wide) long slider type Stroke 100 - 1200mm Load capacity 80kg (horizontal)/19kg (vertical)

n Model specification items Series Type Encoder type Motor output Lead Stroke Applicable controller Cable length Options
ISA[ISPA] - LYM - A - 400 - 40 - 1200 - T1 - S - NM

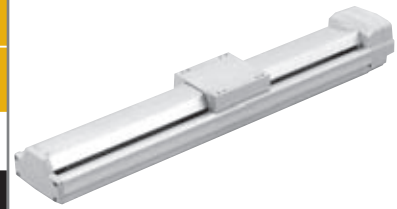

* Refer to page 9 for the details of model specification items.

Models/Specifications

Model	Encoder type	Motor output (W)	Lead (mm)	Stroke (mm) In increments of 50mm (Note 1)	Speed (Note 2) (mm/s)	Acceleration (Note 3)				Load capacity (Note 3)				Rated thrust (N)
						Horizontal (G)		Vertical (G)		Horizontal (kg)		Vertical (kg)		
						Rated	Maximum	Rated	Maximum	Rated acceleration	Maximum acceleration	Rated acceleration	Maximum acceleration	
ISA [ISPA] -LYM-A-400-40-***-T1(2)-△□	Absolute	400	40	100 - 1200	1 ~ 2000	0.3	1.0	0.3	1.0	40	15	9	4	170.0
ISA [ISPA] -LYM-A-400-20-***-T1(2)-△□			20		1 ~ 1000	0.3	1.0	0.3	0.8	80	24	19	10	340.1
ISA [ISPA] -LYM-I-400-40-***-T1(2)-△□	Incremental	40	1 ~ 2000		0.3	1.0	0.3	1.0	40	15	9	4	170.0	
ISA [ISPA] -LYM-I-400-20-***-T1(2)-△□		20	1 ~ 1000		0.3	1.0	0.3	0.8	80	24	19	10	340.1	

* In the above model names, *** indicates the stroke, △ the cable length and □ the applicable options.

*1.0 G=9800mm/sec²

Options

Name	Code	Page	Name	Code	Page
AQ seal	AQ	Ô P11	Master-axis designation	LM	Ô P12
Brake	B	Ô P11	Master-axis designation (sensor on opposite side)	LLM	Ô P12
Creep sensor	C	Ô P11	Reverse homing specification	NM	Ô P12
Creep sensor on opposite side	CL	Ô P11	Guide with ball-retaining mechanism	RT	Ô P12
Home limit switch	L	Ô P12	Slave-axis designation	S	Ô P12
Home limit switch on opposite side	LL	Ô P12	Metal cable joint connector	EU	→ P13

Common Specifications

* Refer to page 8 for the details of common specification items.

Positioning repeatability (Note 4)	±0.02mm [±0.01mm]
Drive system (Note 5)	Ball screw ø20mm, rolled C10 [equivalent to rolled C5]
Backlash (Note 6)	0.05mm or less [0.02mm or less]
Guide	Integrated with base
Allowable load moment	Ma: 104.9Nm Mb: 149.9Nm Mc: 124.5Nm
Overhung load length	Ma direction: 750mm or less, Mb/Mc directions: 750mm or less
Base	Material: Aluminum with white alumite treatment
Cable length (Note 7)	N: No cable, S: 3m, M: 5m, X □ □ : Length specification

Dimensions

* Note that changing the home direction will require the actuator to be returned to IAI for adjustment.

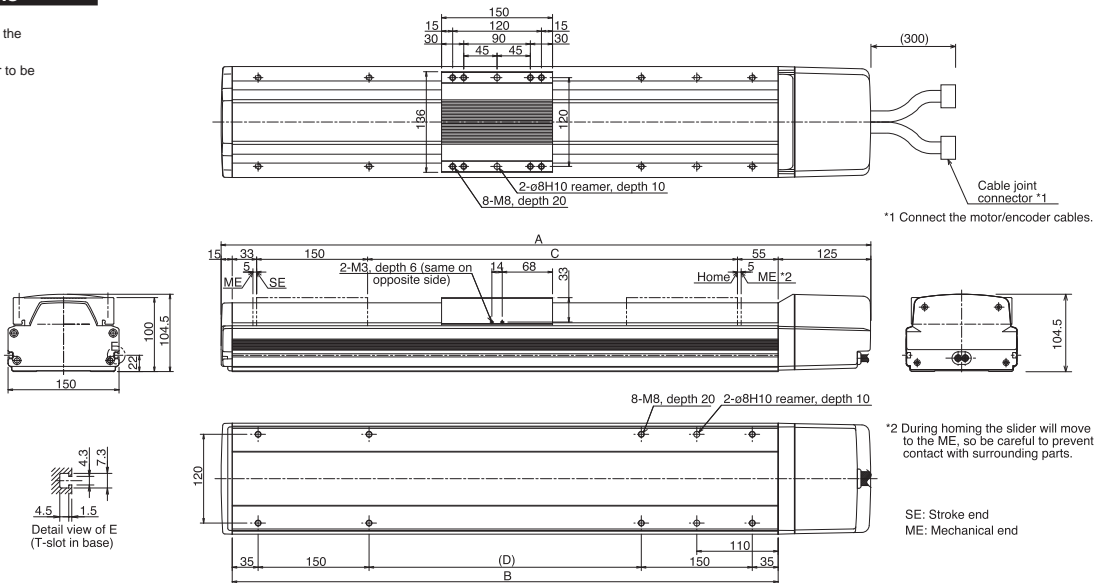

n Dimensions, Weight and Maximum Speed by Stroke

Stroke	100	(150)	200	(250)	300	(350)	400	(450)	500	(550)	600	(650)	700	(750)	800	(850)	900	(950)	1000	(1050)	1100	(1150)	1200
A	478	528	578	628	678	728	778	828	878	928	978	1028	1078	1128	1178	1228	1278	1328	1378	1428	1478	1528	1578
B	338	388	438	488	538	588	638	688	738	788	838	888	938	988	1038	1088	1138	1188	1238	1288	1338	1388	1438
C	100	150	200	250	300	350	400	450	500	550	600	650	700	750	800	850	900	950	1000	1050	1100	1150	1200
D	0	0	1	1	1	1	2	2	2	2	3	3	3	3	4	4	4	4	5	5	5	5	6
Weight (kg)	12.0	12.8	13.5	14.3	15.1	15.9	16.7	17.5	18.3	19.1	19.8	20.6	21.4	22.2	23.0	23.8	24.5	25.3	26.1	26.9	27.7	28.5	29.2
Maximum speed (mm/s)	2000																1660	1380	1170		1000		
	1000																830	690	585		500		

Applicable Controller Specifications

Applicable controller	Maximum number of controlled axes	Compatible encoder type	Program operation	Positioner operation	Pulse-train control	Supply voltage
X-SEL(-P/Q)	4(6) axes	Absolute/incremental		S		AC100/230V
S-SEL	2 axes	Absolute/incremental	○	△		AC100/230V
S-/E-CON	1 axis	Absolute/incremental		○/○	○/-	AC100/230V

Caution

(Note 1) The strokes that are set in increments of 50 mm are semi-standard settings.
 (Note 2) A longer stroke will result in a lower maximum speed to prevent the ball screw from reaching a dangerous speed. (Refer to the above table for the maximum speed at a given stroke.)
 (Note 3) Refer to page 38 for the relationship of acceleration and load capacity. (Notes 4, 5, 6) The figures in brackets apply to the ISPA Series.
 Other specification values apply to both the ISA and ISPA Series.
 (Note 7) The maximum cable length is 30 m. Specify the desired length in meters (e.g., X08 = 8 m).

* Refer to page 7 for other points to note.

ISA-LZM-200 Single-Axis Robot: Large Vertical-Axis Long Slider Type, Actuator Width 150mm, 200W, Straight Shape

ISPA-LZM-200 Single-Axis Robot: Large Vertical-Axis Long Slider Type, Actuator Width 150mm, 200W, Straight Shape **High-Precision Specification**

Type Large vertical-axis (150-mm wide) long slider type Stroke 100 ~ 1200mm Vertical application only (with standard brake) 19kg

Model specification items Series Type Encoder type Motor output Lead Stroke Applicable controller Cable length Options
 ISA[ISPA] - LZM - I - 200 - 10 - 1200 - T1 - S - B - L



* Refer to page 9 for the details of model specification items.

Models/Specifications

Model	Encoder type	Motor output (W)	Lead (mm)	Stroke (mm) In increments of 50mm (Note 1)	Speed (Note 2) (mm/s)	Acceleration (Note 3)				Load capacity (Note 3)		Rated thrust (N)
						Horizontal (G)	Vertical (G)	Horizontal (kg)	Vertical (kg)	Rated acceleration	Maximum acceleration	
ISA [ISPA] -LZM-A-200-10-***-T1(2)-△-B-□	Absolute	200	10	100 ~ 1200	1 ~ 500	Rated	Maximum	Rated	Maximum	19	14	340.1
ISA [ISPA] -LZM-I-200-10-***-T1(2)-△-B-□	Incremental		10		1	500	Vertical application only	0.3	0.5	Vertical application only	19	

* In the above model names, *** indicates the stroke, △ the cable length and □ the applicable options.

*1.0G=9800mm/sec²

Options

Name	Code	Page	Name	Code	Page
AQ seal	AQ	→ P11	Master-axis designation	LM	→ P12
Brake	B	→ P11	Master-axis designation (sensor on opposite side)	LLM	→ P12
Creep sensor	C	→ P11	Reverse homing specification	NM	→ P12
Creep sensor on opposite side	CL	→ P11	Guide with ball-retaining mechanism	RT	→ P12
Home limit switch	L	→ P12	Slave-axis designation	S	→ P12
Home limit switch on opposite side	LL	→ P12	Metal cable joint connector	EU	→ P13

* The MZM type comes standard with a brake (B).

Common Specifications

* Refer to page 8 for the details of common specification items.

Positioning repeatability (Note 4)	±0.02mm [±0.01mm]
Drive system (Note 5)	Ball screw ø16mm, rolled C10 [equivalent to rolled C5]
Backlash (Note 6)	0.05mm or less [0.02mm or less]
Guide	Integrated with base
Allowable load moment	Ma: 104.9Nm Mb: 149.9Nm Mc: 124.5Nm
Brake	Comes standard with a dry, single-plate, non-excitation type electromagnetic brake.
Base	Material: Aluminum with white alumite treatment
Cable length (Note 7)	N: No cable, S: 3m, M: 5m, X□□ : Length specification

Dimensions

* Note that changing the home direction will require the actuator to be returned to IAI for adjustment.

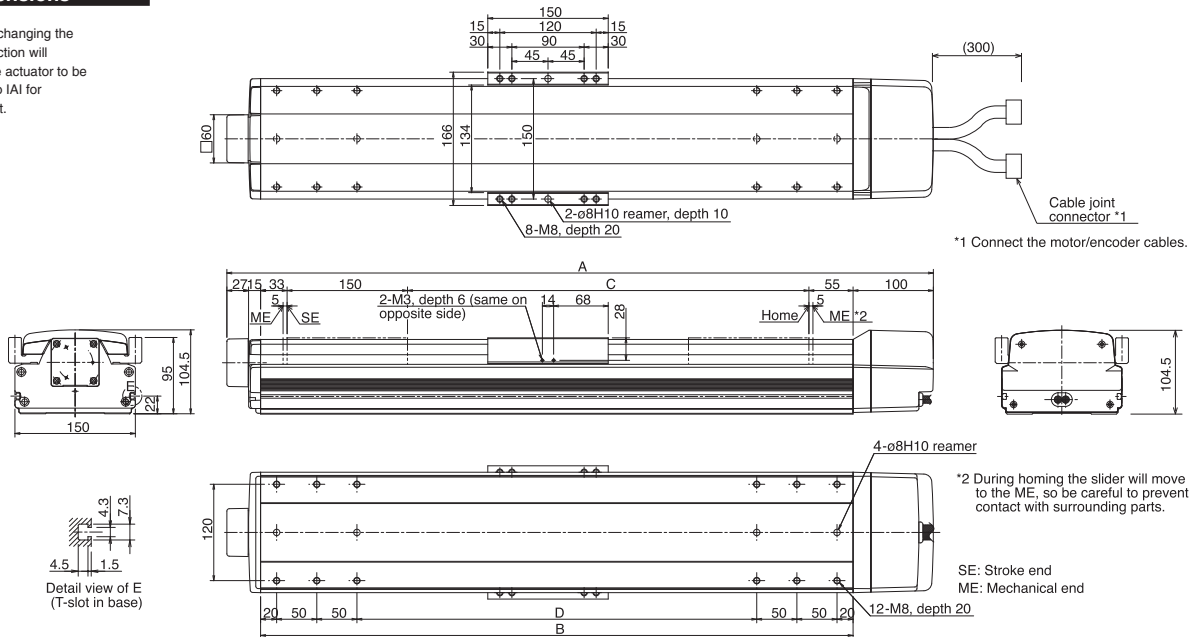

Dimensions, Weight and Maximum Speed by Stroke

Stroke	100	(150)	200	(250)	300	(350)	400	(450)	500	(550)	600	700	800	900	1000	1100	1200
A	480	530	580	630	680	730	780	830	880	930	980	Use the base of the LZM type for 700 and longer strokes. Refer to the drawing on page 23 for the mounting dimensions.					
B	338	388	438	488	538	588	638	688	738	788	838						
C	100	150	200	250	300	350	400	450	500	550	600						
D	98	148	198	248	298	348	398	448	498	548	598						
Weight (kg)	12.4	13.2	13.9	14.7	15.5	16.3	17.1	17.9	18.7	19.5	20.2	21.8	23.4	24.9	26.5	28.1	29.6
Maximum speed (mm/s)	500											500	470	385	320	270	235

Applicable Controller Specifications

Applicable controller	Maximum number of controlled axes	Compatible encoder type	Program operation	Positioner operation	Pulse-train control	Supply voltage
X-SEL(-P/Q)	4(6) axes	Absolute/incremental	○	△		AC100/230V
S-SEL	2 axes	Absolute/incremental	○	△		AC100/230V
S-E-CON	1 axis	Absolute/incremental		○/○	○/-	AC100/230V

* The LZM type comes standard with a brake, so use a controller of brake specification.

Caution

(Note 1) The strokes that are set in increments of 50 mm are semi-standard settings.
 (Note 2) A longer stroke will result in a lower maximum speed to prevent the ball screw from reaching a dangerous speed. (Refer to the above table for the maximum speed at a given stroke.)
 (Note 3) Refer to page 38 for the relationship of acceleration and load capacity. (Notes 4, 5, 6) The figures in brackets apply to the ISPA Series. Other specification values apply to both the ISA and ISPA Series.
 (Note 7) The maximum cable length is 30 m. Specify the desired length in meters (e.g., X08 - 8 m).

* Refer to page 7 for other points to note.

ISA-LZM-400 Single-Axis Robot: Large Vertical-Axis Long Slider Type, Actuator Width 150mm, 400W, Straight Shape

ISPA-LZM-400 Single-Axis Robot: Large Vertical-Axis Long Slider Type, Actuator Width 150mm, 400W, Straight Shape High-Precision Specification

Type Large vertical-axis (150-mm wide) long slider type Stroke 100 ~ 1200mm Vertical application only (with standard brake) 39kg

Model specification items Series Type Encoder type Motor output Lead Stroke Applicable controller Cable length Options
 ISA[ISPA] - LZM - I - 400 - 10 - 1200 - T1 - S - B - L



* Refer to page 9 for the details of model specification items.

Models/Specifications

Model	Encoder type	Motor output (W)	Lead (mm)	Stroke (mm) In increments of 50mm (Note 1)	Speed (Note 2) (mm/s)	Acceleration (Note 3)		Load capacity (Note 3)		Rated thrust (N)	
						Horizontal (G)	Vertical (G)	Horizontal (kg)	Vertical (kg)		
ISA [ISPA] - LZM-A-400-10-***-T1(2)-△-B-□	Absolute	400	10	100 ~ 1200	1 ~ 500	Rated	Maximum	Vertical application only	Rated	Maximum	680.2
ISA [ISPA] - LZM-I-400-10-***-T1(2)-△-B-□	Incremental		10			0.3	0.5		39	28	
						Vertical application only			39	28	

* In the above model names, *** indicates the stroke, △ the cable length and □ the applicable options.

*1.0G=9800mm/sec²

Options

Name	Code	Page	Name	Code	Page
AQ seal	AQ	→ P11	Master-axis designation	LM	→ P12
Brake	B	→ P11	Master-axis designation (sensor on opposite side)	LLM	→ P12
Creep sensor	C	→ P11	Reverse homing specification	NM	→ P12
Creep sensor on opposite side	CL	→ P11	Guide with ball-retaining mechanism	RT	→ P12
Home limit switch	L	→ P12	Slave-axis designation	S	→ P12
Home limit switch on opposite side	LL	→ P12	Metal cable joint connector	EU	→ P13

* The MZM type comes standard with a brake (B).

Common Specifications

* Refer to page 8 for the details of common specification items.

Positioning repeatability (Note 4)	±0.02mm [±0.01mm]		
Drive system (Note 5)	Ball screw ø20mm, rolled C10 [equivalent to rolled C5]		
Backlash (Note 6)	0.05mm or less [0.02mm or less]		
Guide	Integrated with base		
Allowable load moment	Ma: 104.9Nm	Mb: 149.9Nm	Mc: 124.5Nm
Brake	Comes standard with a dry, single-plate, non-excitation type electromagnetic brake.		
Base	Material: Aluminum with white alumite treatment		
Cable length (Note 7)	N: No cable, S: 3m, M: 5m, X□□ : Length specification		

Dimensions

* Note that changing the home direction will require the actuator to be returned to IA1 for adjustment.

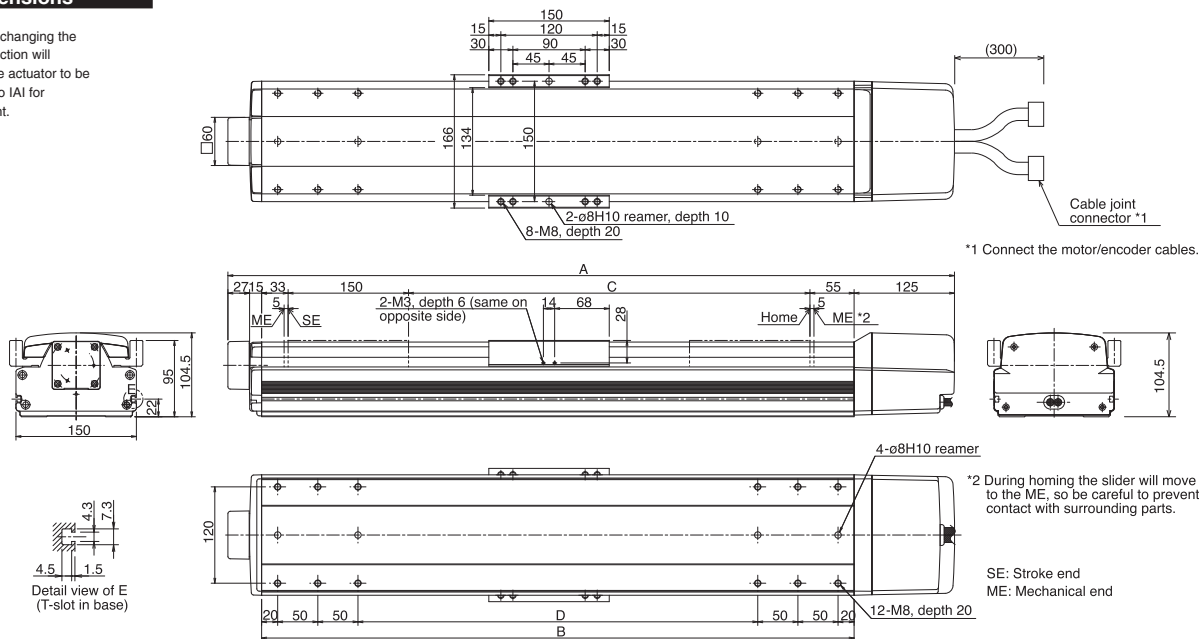

Dimensions, Weight and Maximum Speed by Stroke

Stroke	100	(150)	200	(250)	300	(350)	400	(450)	500	(550)	600	700	800	900	1000	1100	1200
A	505	555	605	655	705	755	805	855	905	955	1005	Use the base of the LXM type for 700 and longer strokes. Refer to the drawing on page 24 for the mounting dimensions.					
B	338	388	438	488	538	588	638	688	738	788	838						
C	100	150	200	250	300	350	400	450	500	550	600						
D	98	148	198	248	298	348	398	448	498	548	598						
Weight (kg)	12.4	13.2	13.9	14.7	15.5	16.3	17.1	17.9	18.7	19.5	20.2	21.8	23.4	24.9	26.5	28.1	29.6
Maximum speed (mm/s)	500											500	470	385	320	270	235

Applicable Controller Specifications

Applicable controller	Maximum number of controlled axes	Compatible encoder type	Program operation	Positioner operation	Pulse-train control	Supply voltage
X-SEL(-P/Q)	4(6) axes	Absolute/incremental	○	△		AC100/230V
S-SEL	2 axes	Absolute/incremental	○	△		AC100/230V
S/E-CON	1 axis	Absolute/incremental		○/○	○/ -	AC100/230V

* The LZM type comes standard with a brake, so use a controller of brake specification.

Caution

(Note 1) The strokes that are set in increments of 50 mm are semi-standard settings.
 (Note 2) A longer stroke will result in a lower maximum speed to prevent the ball screw from reaching a dangerous speed. (Refer to the above table for the maximum speed at a given stroke.)
 (Note 3) Refer to page 38 for the relationship of acceleration and load capacity. (Notes 4, 5, 6) The figures in brackets apply to the ISPA Series. Other specification values apply to both the ISA and ISPA Series.
 (Note 7) The maximum cable length is 30 m. Specify the desired length in meters (e.g., X08 = 8 m).

* Refer to page 7 for other points to note.

ISA-WXM-600 Single-Axis Robot: Super Large X-Axis Long Slider Type, Actuator Width 198mm, 600W, Straight Shape

ISPA-WXM-600 Single-Axis Robot: Super Large X-Axis Long Slider Type, Actuator Width 198mm, 600W, Straight Shape, High-Precision Specification

Type Super large X-axis (198-mm wide) Long slider type Stroke 100~1300mm Load capacity 150kg (horizontal)/60kg (vertical)

Model specification items Series Type Encoder type Motor output Lead Stroke Applicable controller Cable length Options

(Example) ISA -WXM- I - 600 - 40 -1300- T1 - S - C-L



* Refer to page 9 for the details of model specification items.

Models/Specifications

* 1.0G=9800mm/sec²

Model	Encoder Type	Motor output (W)	Lead (mm)	Stroke 100mm increments (mm)	Speed (Note 1) (mm/s)	Acceleration (Note 2)				Load capacity (Note2)				Rated thrust (N)
						Horizontal (G)		Vertical (G)		Horizontal (kg)		Vertical (kg)		
						Rated	Maximum	Rated	Maximum	Rated acceleration	Maximum acceleration	Rated acceleration	Maximum acceleration	
ISA [ISPA]-WXM- [1]-600-40-[2]-[3]-[4]-L-[5]	Absolute	600	40	100 ~ 1300	1 ~ 2000	0.3	1.0	0.2	1.0	60	18	14	5	255
ISA [ISPA]-WXM- [1]-600-20-[2]-[3]-[4]-L-[5]			20		1 ~ 1000	0.3	1.0	0.2	0.8	120	36	29	15	510
ISA [ISPA]-WXM- [1]-600-10-[2]-[3]-[4]-L-[5]			10		1 ~ 500	0.3	0.6	0.2	0.5	150	75	60	40	1020

* In the above model names, [1] indicates the encoder type, [2] the stroke, [3] the applicable controller, [4] the cable length, and [5] the applicable options.

Options

Name	Code	Page	Name	Code	Page
AQ seal	AQ	→P11	Master-axis designation	LM	→P12
Brake	B	→P11	Reversed home specification	NM	→P12
Creep sensor	C	→P11	Slave-axis designation	S	→P12
Home limit switch	L	→P12	Metal cable joint connector	EU	→P13

* The WXM type comes standard with home limit switch (code: L).

Common Specifications

* The specifications of the ISPA are shown in [].

Positioning repeatability	0.02mm [0.01mm]
Drive system	Ball screw ø20mm, equivalent to rolled C10 [equivalent to C5]
Backlash	0.05mm or less [0.02mm or less]
Guide	Integrated with base
Allowable load moment	Ma: 139.2Nm, Mb: 199.9Nm, Mc: 391Nm
Overhang load length	Ma/Mb/Mc directions: 900mm or less
Base	Material: Aluminum with white alumite treatment
Applicable controller	T1: XSEL-KE/KT, E-Con, P-Driver, T2: XSEL-P/Q
Cable length (Note 3)	N: No cable, S: 3m, M: 5m, X□□: Length specification
Ambient operating temperature/humidity	0~40°C, 85% RH (non-condensing)

Dimensions

* Those equipped with an optional brake have the same external dimensions, but the weight increases by 0.5 kg.

* To change the home direction, the actuator must be returned to IAI for adjustment.

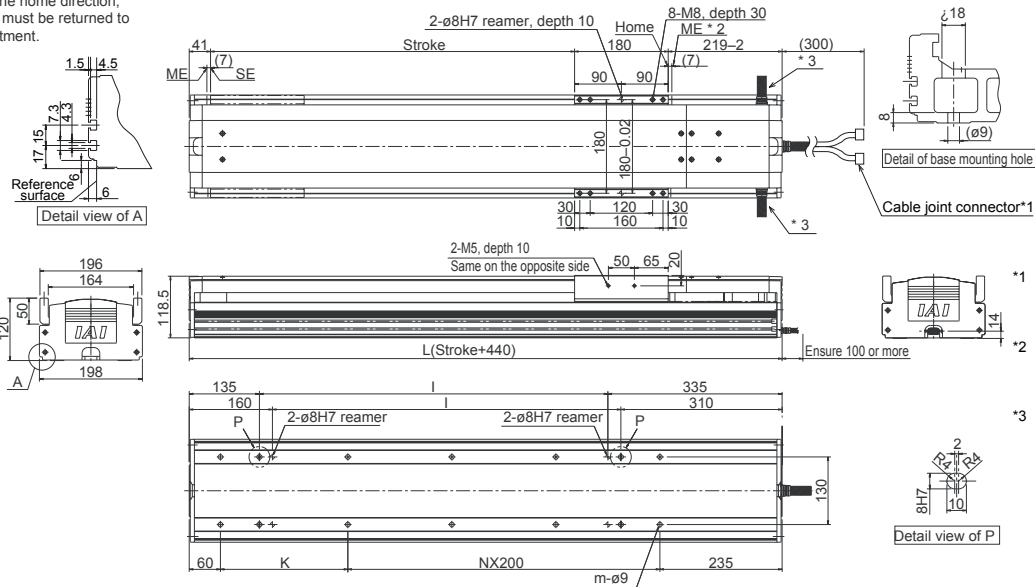

- *1 Connect the motor cable and encoder cable here. SE: Stroke end ME: Mechanical end
- *2 During home return, the slider will move to the ME, so be careful to prevent contact with surrounding parts.
- *3 The cable outlet direction can be changed to right or left at the customer's site.

Dimensions, Weight and Maximum Speed by Stroke

Stroke	100	200	300	400	500	600	700	800	900	1000	1100	1200	1300	
L	540	640	740	840	940	1040	1140	1240	1340	1440	1540	1640	1740	
I	70	170	270	370	470	570	670	770	870	970	1070	1170	1270	
K	245	145	245	145	245	145	245	145	245	145	245	145	245	
N	-	1	1	2	2	3	3	4	4	5	5	6	6	
m	4	6	6	8	8	10	10	12	12	14	14	16	16	
Weight (kg)	18.1	20.1	22.1	24.1	26.1	28.0	30.0	32.0	34.0	35.9	37.9	39.9	41.9	
Maximum speed (mm/s) * Varies depending on the stroke.	Lead 40	2000								1670	1390	1170	1000	865
	Lead 20	1000								835	695	585	500	430
	Lead 10	500								415	345	290	250	215

Applicable Controller Specifications

Applicable controller	Maximum number of controlled axes	Compatible encoder type	Operating method	Supply voltage
X-SEL(-P/Q)	4(6) axes	Absolute /incremental	Program or Positioner	AC100/230V
S-SEL	2 axes		Positioner	AC230V
S-/E-CON	1 axis		(S-CON: also pulse train)	AC230V

* The WXM type comes standard with home limit switch, so use it with a controller of the limit switch specification.



- (Note 1) When the stroke increases, the maximum speed drops in order to prevent the ball screw from reaching a dangerous speed. (Refer to the above table for the maximum speed at each stroke.)
- (Note 2) Refer to page 38 for the relationship of acceleration and load capacity.
- (Note 3) The maximum cable length is 30 m. Specify a desired length in meters. (Example: X08 = 8 m)

ISA-WXM-750 Single-Axis Robot: Super Large X-Axis Long Slider Type, Actuator Width 198mm, 750W, Straight Shape

ISPA-WXM-750 Single-Axis Robot: Super Large X-Axis Long Slider Type, Actuator Width 198mm, 750W, Straight Shape, High-Precision Specification

Type Super large X-axis (198-mm wide) Long slider type Stroke 100~1300mm Load capacity 120kg (horizontal)/29kg (vertical)

Model specification items Series Type Encoder type Motor output Lead Stroke Applicable controller Cable length Options

(Example) ISA -WXM- I - 750 - 50 -1300- T1 - S -C-L

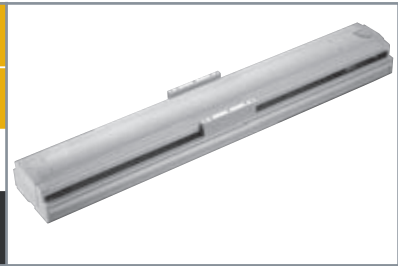

* Refer to page 9 for the details of model specification items.

Models/Specifications

Model	Encoder Type	Motor output (W)	Lead (mm)	Stroke 100mm increments (mm)	Speed (Note 1) (mm/s)	Acceleration (Note 2)				Load capacity (Note2)				Rated thrust (N)
						Horizontal (G)		Vertical (G)		Horizontal (kg)		Vertical (kg)		
						Rated	Maximum	Rated	Maximum	Rated acceleration	Maximum acceleration	Rated acceleration	Maximum acceleration	
ISA [ISA]-WXM- [1]-750-50-[2]-[3]-L-[5]	Absolute	750	50	100 ~ 1300	1 ~ 2000	0.3	1.0	0.2	1.0	60	18	14	5	255
ISA [ISPA]-WXM- [1]-750-25-[2]-[3]-L-[5]	Incremental		25		1 ~ 1250	0.3	1.0	0.2	0.8	120	36	29	15	510

* In the above model names, [1] indicates the encoder type, [2] the stroke, [3] the applicable controller, [4] the cable length, and [5] the applicable options.

Options

Name	Code	Page	Name	Code	Page
AQ seal	AQ	→P11	Master-axis designation	LM	→P12
Brake	B	→P11	Reversed home specification	NM	→P12
Creep sensor	C	→P11	Slave-axis designation	S	→P12
Home limit switch	L	→P11	Metal cable joint connector	EU	→P13

* The WXM type comes standard with home limit switch (code: L).

Common Specifications

* The specifications of the ISPA are shown in [].

Positioning repeatability	±0.02mm [±0.01mm]
Drive system	Ball screw ø20mm, equivalent to rolled C10 [equivalent to C5]
Backlash	0.05mm or less [0.02mm or less]
Guide	Integrated with base
Allowable load moment	Ma: 139.2N · m, Mb: 199.9N · m, Mc: 391N · m
Overhang load length	Ma/Mb/Mc directions: 900mm or less
Base	Material: Aluminum with white alumite treatment
Applicable controller	T1: XSEL-KE/KT, E-Con, P-Driver, T2: XSEL-P/Q
Cable length (Note 3)	N: No cable, S: 3m, M: 5m, X□□: Length specification
Ambient operating temperature/humidity	0~40°C, 85% RH (non-condensing)

Dimensions

* Those equipped with an optional brake have the same external dimensions, but the weight increases by 0.5 kg.

* To change the home direction, the actuator must be returned to IA1 for adjustment.

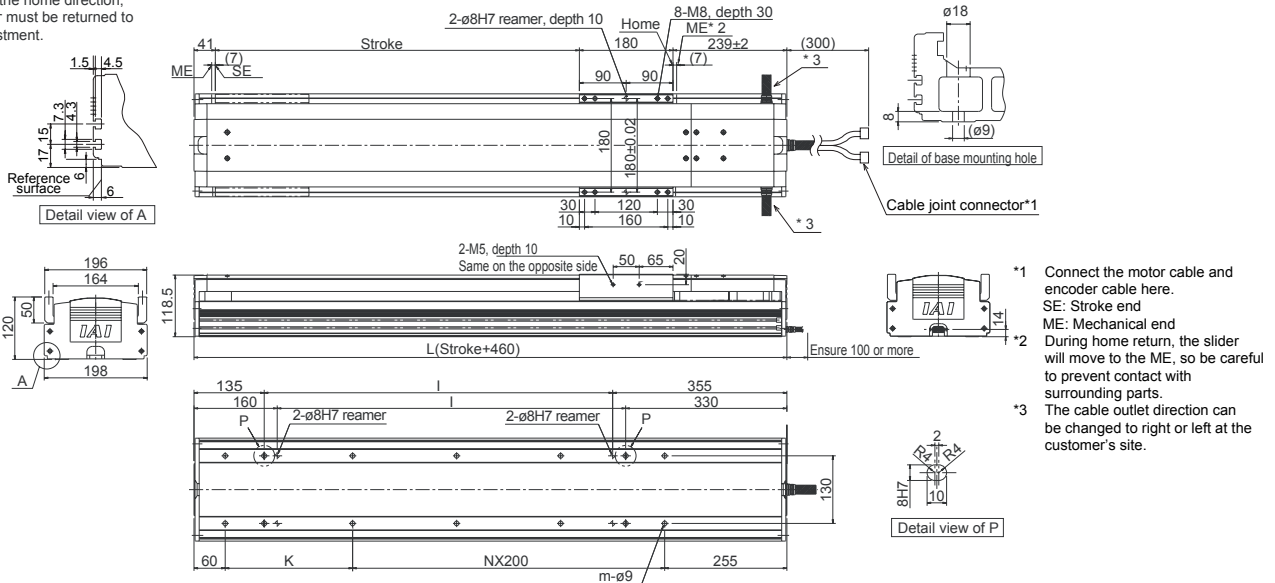

Dimensions, Weight and Maximum Speed by Stroke

Stroke	100	200	300	400	500	600	700	800	900	1000	1100	1200	1300
L	560	660	760	860	960	1060	1160	1260	1360	1460	1560	1660	1760
l	70	170	270	370	470	570	670	770	870	970	1070	1170	1270
K	245	145	245	145	245	145	245	145	245	145	245	145	245
N	-	1	1	2	2	3	3	4	4	5	5	6	6
m	4	6	6	8	8	10	10	12	12	14	14	16	16
Weight (kg)	20.9	22.9	24.9	26.9	28.9	30.8	32.8	34.8	36.8	38.7	40.7	42.7	44.7
Maximum speed (mm/s) * Varies depending on the stroke.	Lead 40									2000	1840	1570	1360
	Lead 25									1090	920	785	680

Applicable Controller Specifications

Applicable controller	Maximum number of controlled axes	Compatible encoder type	Operating method	Supply voltage
X-SEL-(P/Q)	4(6) axes	Absolute /incremental	Program or Positioner	AC100/230V
S-SEL	2 axes		Positioner	AC230V
S-/E-CON	1 axis		(S-CON: also pulse train)	AC230V

* The WXM type comes standard with home limit switch, so use it with a controller of the limit switch specification.

Caution

(Note 1) When the stroke increases, the maximum speed drops in order to prevent the ball screw from reaching a dangerous speed. (Refer to the above table for the maximum speed at each stroke.)

(Note 2) Refer to page 38 for the relationship of acceleration and load capacity.

(Note 3) The maximum cable length is 30 m. Specify a desired length in meters. (Example: X08 = 8 m)

ISA-WXM-600 Single-Axis Robot: Super Large X-axis Mid-support Type, Actuator Width 198mm, 600W, Straight Shape
ISPA-WXM-600 Single-Axis Robot: Super Large X-axis Mid-support Type, Actuator Width 198mm, 600W, Straight Shape, High-Precision Specification

Type Super large X-axis (198-mm wide) Mid-support type Stroke 900~2500mm Load capacity 120kg (horizontal)

Model specification items Series Type Encoder type Motor output Lead Stroke Applicable controller Cable length Options
 (Example) ISA -WXM- I - 600 - 40 -2500- T1 - S -C-L

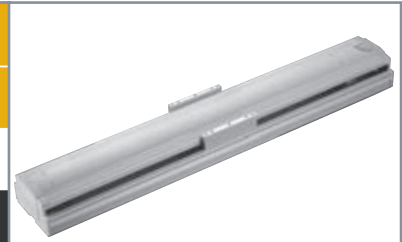

* Refer to page 9 for the details of model specification items.

Models/Specifications

Model	Encoder Type	Motor output (W)	Lead (mm)	Stroke 100mm increments (mm)	Speed (Note 1) (mm/s)	Acceleration (Note 2)				Load capacity (Note2)				Rated thrust (N)
						Horizontal (G)		Vertical (G)		Horizontal (kg)		Vertical (kg)		
						Rated	Maximum	Rated	Maximum	Rated	Maximum	Rated	Maximum	
ISA [ISPA]-WXM- [1]-600-40-[2]-[3]-L-[5]	Absolute	600	40	900 ~ 2500	1 ~ 2000	0.3		Horizontal only		60		Horizontal only		255
ISA [ISPA]-WXM- [1]-600-20-[2]-[3]-L-[5]	Incremental		20		1 ~ 1250	0.3				120				510

*In the above model names, [1] indicates the encoder type, [2] the stroke, [3] the applicable controller, [4] the cable length, and [5] the applicable options.

Options

Name	Code	Page	Name	Code	Page
AQ seal	AQ	→P11	Master-axis designation	LM	→P12
Brake	B	→P11	Reversed home specification	NM	→P12
Creep sensor	C	→P11	Slave-axis designation	S	→P12
Home limit switch	L	→P12	Metal cable joint connector	EU	→P13

* The WXM type comes standard with home limit switch (code: L).

Common Specifications

* The specifications of the ISPA are shown in [].

Positioning repeatability	±0.02mm [±0.01mm]
Drive system	Ball screw ø20mm, equivalent to rolled C10 [equivalent to C5]
Backlash	0.05mm or less [0.02mm or less]
Guide	Integrated with base
Allowable load moment	Ma: 139.2N · m, Mb: 199.9N · m, Mc: 391N · m
Overhang load length	Ma/Mb/Mc directions: 900mm or less
Base	Material: Aluminum with white alumite treatment
Applicable controller	T1: XSEL-KE/KT, E-Con, P-Driver, T2: XSEL-P/Q
Cable length (Note 3)	N: No cable, S: 3m, M: 5m, X□□: Length specification
Ambient operating temperature/humidity	0~40°C, 85% RH (non-condensing)

Dimensions

* To change the home direction, the actuator must be returned to IA1 for adjustment.
 * Due to their structure, the mid-support type cannot be positioned horizontally on their side, or in the vertical direction.

* Those equipped with an optional brake have the same external dimensions, but the weight increases by 0.5 kg.

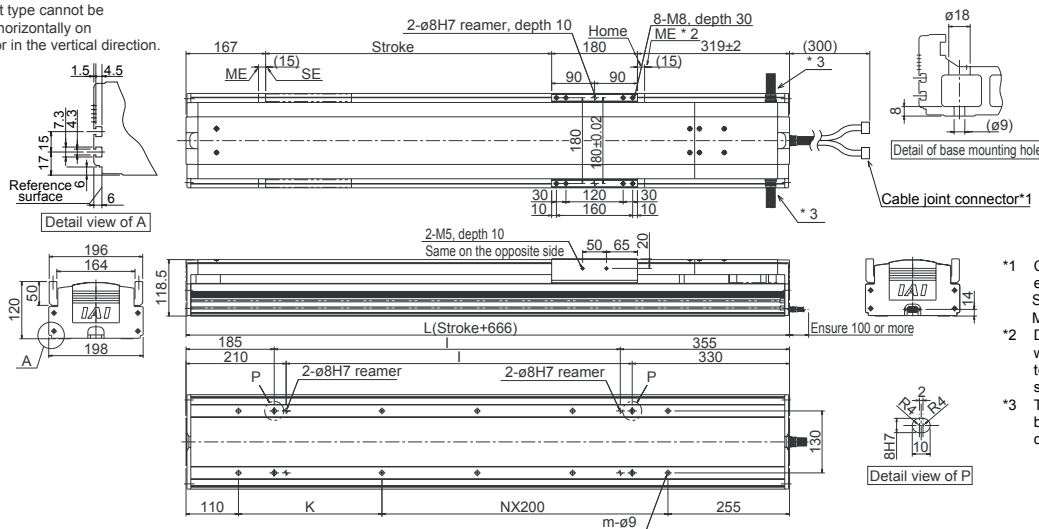

- *1 Connect the motor cable and encoder cable here. SE: Stroke end ME: Mechanical end
- *2 During home return, the slider will move to the ME, so be careful to prevent contact with surrounding parts.
- *3 The cable outlet direction can be changed to right or left at the customer's site.

Dimensions, Weight and Maximum Speed by Stroke

Stroke	900	1000	1100	1200	1300	1400	1500	1600	1700	1800	1900	2000	2100	2200	2300	2400	2500	
L	1566	1666	1766	1866	1966	2066	2166	2266	2366	2466	2566	2666	2766	2866	2966	3066	3166	
I	1026	1126	1226	1326	1426	1526	1626	1726	1826	1926	2026	2126	2226	2326	2426	2526	2626	
K	201	301	201	301	201	301	201	301	201	301	201	301	201	301	201	301	201	
N	5	5	6	6	7	7	8	8	9	9	10	10	11	11	12	12	13	
m	14	14	16	16	18	18	20	20	22	22	24	24	26	26	28	28	30	
Weight (kg)	38.6	40.6	42.6	44.6	46.6	48.5	50.5	52.5	54.5	56.5	58.4	60.4	62.4	64.4	66.3	68.3	70.3	
Maximum speed (mm/s)	Lead 40		2000				1965	1725	1530	1365	1225	1110	1005	915	840	770	710	655
	Lead 20		1000				980	860	765	680	610	555	500	455	420	385	355	325

Maximum speed (mm/s)
 * Varies depending on the stroke.

Applicable Controller Specifications

Applicable controller	Maximum number of controlled axes	Compatible encoder type	Operating method	Supply voltage
X-SEL-(P/Q)	4(6) axes	Absolute /incremental	Program or Positioner	AC100/230V
S-SEL	2 axes		Positioner	AC230V
S-E-CON	1 axis		(S-CON: also pulse train)	AC230V



(Note 1) When the stroke increases, the maximum speed drops in order to prevent the ball screw from reaching a dangerous speed. (Refer to the above table for the maximum speed at each stroke.)
 (Note 2) Refer to page 38 for the relationship of acceleration and load capacity.
 (Note 3) The maximum cable length is 30 m. Specify a desired length in meters. (Example: X08 = 8 m)

* The WXM type comes standard with home limit switch, so use it with a controller of the limit switch specification.

ISA-WXMX-750 Single-Axis Robot: Super Large X-axis Mid-support Type, Actuator Width 198mm, 750W, Straight Shape

ISPA-WXMX-750 Single-Axis Robot: Super Large X-axis Mid-support Type, Actuator Width 198mm, 750W, Straight Shape, High-Precision Specification

Type Super large X-axis (198-mm wide) Mid-support type | Stroke 900~2500mm | Load capacity 120kg (horizontal)

Model specification items Series Type Encoder type Motor output Lead Stroke Applicable controller Cable length Options

(Example) ISA - WXMX - I - 750 - 50 - 2500 - T1 - S - C - L

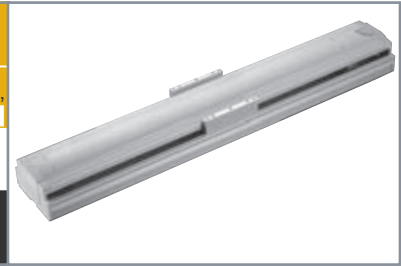

* Refer to page 9 for the details of model specification items.

Models/Specifications

* 1.0G=9800mm/sec²

Model	Encoder Type	Motor output (W)	Lead (mm)	Stroke 100mm increments (mm)	Speed (Note 1) (mm/s)	Acceleration (Note 2)				Rated thrust (N)		
						Horizontal (G)		Vertical (G)			Horizontal (kg)	Vertical (kg)
						Rated	Maximum	Rated	Maximum			
ISA [ISA]-WXMX-[1]-750-50-[2]-[3]-L-[5]	Absolute	750	50	900 ~ 2000	1 ~ 2000	0.3		Horizontal only		60	Horizontal only	255
ISA [ISA]-WXMX-[1]-750-25-[2]-[3]-L-[5]	Incremental		25			1 ~ 1250	0.3		Horizontal only		120	Horizontal only

* In the above model names, [1] indicates the encoder type, [2] the stroke, [3] the applicable controller, [4] the cable length, and [5] the applicable options.

Options

Name	Code	Page	Name	Code	Page
AQ seal	AQ	→P11	Master-axis designation	LM	→P12
Brake	B	→P11	Reversed home specification	NM	→P12
Creep sensor	C	→P11	Slave-axis designation	S	→P12
Home limit switch	L	→P11	Metal cable joint connector	EU	→P13

* The WXMX type comes standard with home limit switch (code: L).

Common Specifications

* The specifications of the ISPA are shown in [].

Positioning repeatability	±0.02mm [±0.01mm]
Drive system	Ball screw ø20mm, equivalent to rolled C10 [equivalent to C5]
Backlash	0.05mm or less [0.02mm or less]
Guide	Integrated with base
Allowable load moment	Ma: 139.2N · m, Mb: 199.9N · m, Mc: 391N · m
Overhang load length	Ma/Mb/Mc directions: 900mm or less
Base	Material: Aluminum with white alumite treatment
Applicable controller	T1: XSEL-KE/KT, E-Con, P-Driver, T2: XSEL-P/Q
Cable length (Note 3)	N: No cable, S: 3m, M: 5m, X □ □: Length specification
Ambient operating temperature/humidity	0~40°C, 85% RH (non-condensing)

Dimensions

* Those equipped with an optional brake have the same external dimensions, but the weight increases by 0.5 kg.

* To change the home direction, the actuator must be returned to IAI for adjustment.
 * Due to their structure, the mid-support type cannot be positioned horizontally on their side, or in the vertical direction.

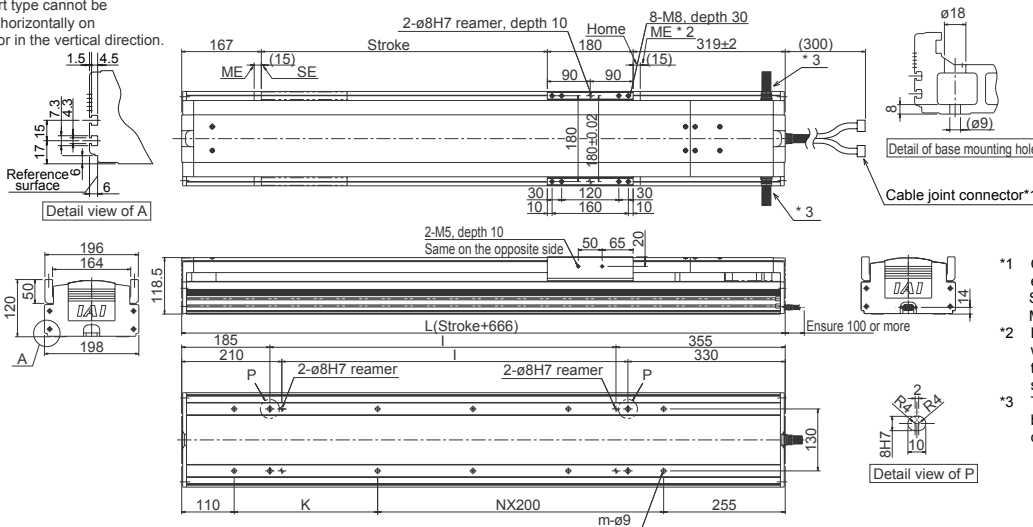

- *1 Connect the motor cable and encoder cable here.
- SE: Stroke end
- ME: Mechanical end
- *2 During home return, the slider will move to the ME, so be careful to prevent contact with surrounding parts.
- *3 The cable outlet direction can be changed to right or left at the customer's site.

Dimensions, Weight and Maximum Speed by Stroke

Stroke	900	1000	1100	1200	1300	1400	1500	1600	1700	1800	1900	2000	2100	2200	2300	2400	2500	
L	1566	1666	1766	1866	1966	2066	2166	2266	2366	2466	2566	2666	2766	2866	2966	3066	3166	
I	1026	1126	1226	1326	1426	1526	1626	1726	1826	1926	2026	2126	2226	2326	2426	2526	2626	
K	201	301	201	301	201	301	201	301	201	301	201	301	201	301	201	301	201	
N	5	5	6	6	7	7	8	8	9	9	10	10	11	11	12	12	13	
m	14	14	16	16	18	18	20	20	22	22	24	24	26	26	28	28	30	
Weight (kg)	41.4	43.4	45.4	47.4	49.4	51.3	53.3	55.3	57.3	59.3	61.2	63.2	65.2	67.2	69.1	71.1	73.1	
Maximum speed (mm/s) * Varies depending on the stroke.	Lead 50	2000							1930	1740	1580	1440	1320	1210	1115	1035		
	Lead 25	1250							1200	1075	965	870	790	720	660	605	555	515

Applicable Controller Specifications

Applicable controller	Maximum number of controlled axes	Compatible encoder type	Operating method	Supply voltage
X-SEL-(P/Q)	4(6) axes	Absolute /incremental	Program or Positioner	AC100/230V
S-SEL	2 axes		Positioner	AC230V
S-/E-CON	1 axis		Positioner (S-CON: also pulse train)	AC230V

* The WXMX type comes standard with home limit switch, so use it with a controller of the limit switch specification.

Caution

(Note 1) When the stroke increases, the maximum speed drops in order to prevent the ball screw from reaching a dangerous speed. (Refer to the above table for the maximum speed at each stroke.)

(Note 2) Refer to page 38 for the relationship of acceleration and load capacity.

(Note 3) The maximum cable length is 30 m. Specify a desired length in meters. (Example: X08 = 8 m)

Technical Information

How to Calculate Positioning Time

Positioning time of the actuator can be calculated.

The following two operation patterns are applicable depending on the travel distance and acceleration/deceleration condition.

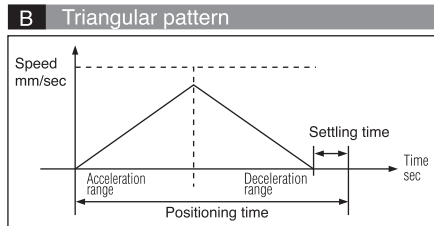
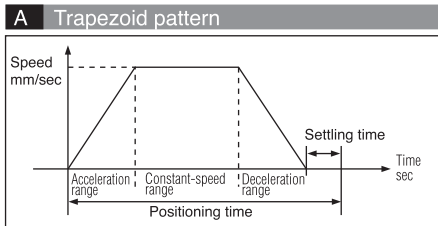

First, check whether the operation in question conforms to the trapezoid pattern or triangular pattern and then calculate positioning time using the applicable equation.

How to Determine Operation Pattern

Whether an operation conforms to the trapezoid pattern or triangular pattern can be determined by identifying if the attained speed is higher or lower than the specified speed when the actuator is operated over the target travel distance at the specified acceleration.

$$\begin{aligned} \text{Attained speed (Vmax)} &= \sqrt{\text{Travel distance (Smm)} \times \text{Specified acceleration}} \\ &= \sqrt{\text{Smm} \times 9,800\text{mm/sec}^2 \times \text{Acceleration setting (G)}} \end{aligned}$$

One of the following two results will be obtained:

- Specified speed (V) < Attained speed (Vmax) ----- Trapezoid pattern
- Specified speed (V) > Attained speed (Vmax) ----- Triangular pattern

How to Calculate Positioning Time

A Trapezoid pattern

$$\text{Positioning time (T)} = \frac{\text{Distance (mm)}}{\text{Speed (mm/sec)}} + \frac{\text{Speed (mm/sec)}}{\text{Acceleration (mm/sec}^2)} + \text{Settling time}$$

B Triangular pattern

$$\text{Positioning time} = 2 \sqrt{\frac{\text{Distance (mm)}}{\text{Acceleration (mm/sec}^2)}} + \text{Settling time}$$

$$\begin{aligned} \text{Acceleration time} &= \frac{\text{Speed* (mm/sec)}}{\text{Acceleration (mm/sec}^2)} \\ \text{Travel time during acceleration} &= \frac{\text{Acceleration (mm/sec}^2) \times (\text{Acceleration time (sec)})^2}{2} \end{aligned}$$

* Use the specified speed for the trapezoid pattern and attained speed for the triangular pattern.

Note • Obtain acceleration by multiplying the controller's acceleration/deceleration setting (G) by 9800 mm/sec². If the controller's acceleration/deceleration setting is 0.3 G, acceleration is calculated as 0.3 x 9800 mm/sec² = 2940 mm/sec².
• Settling time is a period used for determining if the operation to the target position has completed. Normally a settling time of approx. 0.15 sec should be considered for a ball-screw type and 0.2 sec, for a belt type.

Positioning Time

Specified acceleration	Specified speed	Travel distance (mm)																		
		10	20	30	40	50	100	150	200	250	300	350	400	450	500	600	1000	1100	1300	1400
0.3G	100	0.13	0.23	0.33	0.43	0.53	1.03	1.53	2.03	2.53	3.03	3.53	4.03	4.53	5.03	6.03	10.03	11.03	13.03	14.03
	200	0.12	0.17	0.22	0.27	0.32	0.57	0.82	1.07	1.32	1.57	1.82	2.07	2.32	2.57	3.07	5.07	5.57	6.57	7.07
	300	0.12	0.16	0.2	0.24	0.27	0.44	0.6	0.77	0.94	1.1	1.27	1.44	1.6	1.77	2.1	3.44	3.77	4.44	4.77
	400	0.12	0.16	0.2	0.23	0.26	0.39	0.51	0.64	0.76	0.89	1.01	1.14	1.26	1.39	1.64	2.64	2.89	3.39	3.64
	500	0.12	0.16	0.2	0.23	0.26	0.37	0.47	0.57	0.67	0.77	0.87	0.97	1.07	1.17	1.37	2.17	2.37	2.77	2.97
	600	0.12	0.16	0.2	0.23	0.26	0.37	0.45	0.54	0.62	0.7	0.79	0.87	0.95	1.04	1.2	1.87	2.04	2.37	2.54
	700	0.12	0.16	0.2	0.23	0.26	0.37	0.45	0.52	0.6	0.67	0.74	0.81	0.88	0.95	1.1	1.67	1.81	2.1	2.24
	800	0.12	0.16	0.2	0.23	0.26	0.37	0.45	0.52	0.58	0.65	0.71	0.77	0.83	0.9	1.02	1.52	1.65	1.9	2.02
	900	0.12	0.16	0.2	0.23	0.26	0.37	0.45	0.52	0.58	0.64	0.7	0.75	0.81	0.86	0.97	1.42	1.53	1.75	1.86
	1000	0.12	0.16	0.2	0.23	0.26	0.37	0.45	0.52	0.58	0.64	0.69	0.74	0.79	0.84	0.94	1.34	1.44	1.64	1.74
1750	0.12	0.16	0.2	0.23	0.26	0.37	0.45	0.52	0.58	0.64	0.69	0.74	0.78	0.82	0.9	1.17	1.37	1.56	1.65	
2000	0.12	0.16	0.2	0.23	0.26	0.37	0.45	0.52	0.58	0.64	0.69	0.74	0.78	0.82	0.9	1.17	1.22	1.33	1.48	

(Note) The above figures do not include settling time (0.15 sec for ball screw, 0.2 sec for belt). Triangular pattern

Acceleration Time

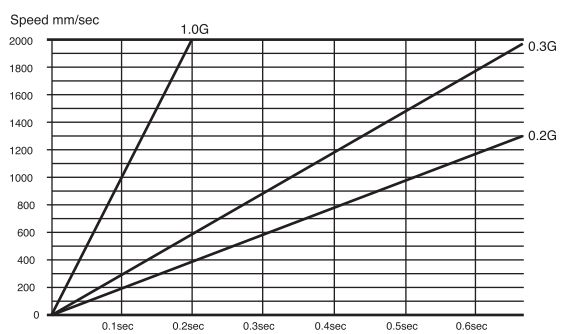

ISA/ISPA Series Table of Load Capacity by Acceleration Condition

- Caution 1. The load capacity values shown below are provided for reference purposes only. They are not guaranteed and must therefore be used only as guidelines.
2. Even when the acceleration is below the rated acceleration, the load capacity will not increase beyond the load capacity at the rated acceleration.
3. Use models other than those in the ISA/ISPA Series at accelerations below their rated acceleration

ISA / ISPA

Type	Motor output (W)	Lead (mm)	Maximum speed (mm/sec)	Rated acceleration (G)	Load capacity at rated acceleration (kg)		Maximum acceleration (G)	Load capacity at each acceleration (kg)							
								0.3G	0.4G	0.5G	0.6G	0.7G	0.8G	0.9G	1.0G
SXM	60	16	800	0.3	Horizontal	12	1.0	12	9	7	6	5	4.5	4	3.5
					Vertical	3	0.7	3	2.5	2.3	2.1	2	-	-	-
SYM	60	8	400	0.3	Horizontal	25	0.6	25	18.5	15	12	-	-	-	-
					Vertical	6	0.5	6	5.5	5	-	-	-	-	-
SZM	60	4	200	0.15	Horizontal	50	0.5	50	37.5	30	-	-	-	-	-
					Vertical	14	0.3	12	-	-	-	-	-	-	-
SZM	60	8	400	0.3	Vertical	6	0.3	6	5.5	5	-	-	-	-	-
					Vertical	4	0.15	14	-	-	-	-	-	-	-
MXM	100	20	1000	0.3	Horizontal	20	1.0	20	15	12	10	8.5	7.5	6.5	6
					Vertical	3.5	0.8	3.5	3.2	2.9	2.7	2.4	2	-	-
MYM	100	10	500	0.3	Horizontal	40	0.6	40	30	24	20	-	-	-	-
					Vertical	9	0.5	9	7.6	7	-	-	-	-	-
MZM	100	5	250	0.15	Horizontal	80	0.5	80	60	45	-	-	-	-	-
					Vertical	19	0.3	15	-	-	-	-	-	-	-
MXM	200	30	1500	0.3	Horizontal	25	1.0	25	20	17	15	13.5	12	11	10
					Vertical	6	1.0	6	4.7	4.3	3.9	3.6	3.4	3.1	2
MYM	200	20	1000	0.3	Horizontal	40	1.0	40	30	24	20	17	15	13.5	12
					Vertical	9	0.8	9	7.6	7	6.5	6	5	-	-
MZM	200	10	500	0.3	Horizontal	80	0.6	80	60	48.5	40	-	-	-	-
					Vertical	19	0.5	19	16.3	15	-	-	-	-	-
MXMX	200	30	1500	0.3	Horizontal	25	0.3	25	-	-	-	-	-	-	-
					Horizontal	20	1000	0.3	40	0.3	40	-	-	-	-
LXM	200	20	1000	0.3	Horizontal	40	1.0	40	30	24	20	17	15	13.5	12
					Vertical	9	0.8	9	6.6	6	5.5	5	4	-	-
LYM	200	10	500	0.3	Horizontal	80	0.6	80	60	48.5	40	-	-	-	-
					Vertical	19	0.5	19	15.3	14	-	-	-	-	-
LXM	400	40	2000	0.3	Horizontal	40	1.0	40	30	25	22	20	18	16.5	15
					Vertical	9	1.0	9	6.6	6	5.5	5	4.6	4.3	4
LYM	400	20	1000	0.3	Horizontal	80	1.0	80	60.5	48.5	40.5	34.5	30	27	24
					Vertical	19	0.8	19	15.3	14.1	13.1	12.2	10	-	-
LZM	400	10	500	0.3	Vertical	39	0.5	39	32.6	28	-	-	-	-	-
					Horizontal	200	20	1000	0.3	40	0.3	40	-	-	-
LXMX	400	40	2000	0.3	Horizontal	40	0.3	40	-	-	-	-	-	-	-
					Horizontal	20	1000	0.3	80	0.3	80	-	-	-	-
LXUWX	400	20	1000	0.3	Horizontal	40	0.3	40	-	-	-	-	-	-	-
					Horizontal	40	2000	0.3	40	0.3	40	-	-	-	-
WXM	600	40	2000	0.3	Horizontal	60	1.0	60	45	36	30	26	22	20	18
					Vertical	14	1.0	10	9	8.1	7.4	6.7	6.1	5.6	5
WXM	600	20	1000	0.3	Horizontal	120	1.0	120	91	72	60	52	45	40	36
					Vertical	29	0.8	24	22	20.3	18.8	17.4	15	-	-
WXM	750	10	500	0.3	Horizontal	150	0.6	150	112	90	75	-	-	-	-
					Vertical	60	0.5	52	48	40	-	-	-	-	-
WXM	750	50	2000	0.3	Horizontal	60	1.0	60	45	36	30	26	22	20	18
					Vertical	14	1.0	10	9	8.1	7.4	6.7	6.1	5.6	5
WXM	750	25	1250	0.3	Horizontal	120	1.0	120	91	72	60	52	45	40	36
					Vertical	29	0.8	24	22	20.3	18.8	17.4	15	-	-
WXM	600	40	2000	0.3	Horizontal	60	0.3	60	-	-	-	-	-	-	-
					Horizontal	20	1000	0.3	120	0.3	120	-	-	-	-
WXM	750	50	2000	0.3	Horizontal	60	0.3	60	-	-	-	-	-	-	-
					Horizontal	25	1250	0.3	120	0.3	120	-	-	-	-

**ISA Series
Catalogue No. 0406-E**

The information contained in this catalog is subject to change without notice for the purpose of product improvement



Providing quality products
since 1986



IAI Industrieroboter GmbH
Ober der Röth 4
D-65824 Schwalbach / Frankfurt
Germany
Tel.:+49-6196-8895-0
Fax:+49-6196-8895-24
E-Mail: info@IAI-GmbH.de
Internet: <http://www.eu.IAI-GmbH.de>

IAI America Inc.

2690 W. 237th Street, Torrance, CA 90505, U.S.A
Tel.: +1-310-891-6015 Fax: +1-310-891-0815

IAI CORPORATION

645-1 Shimizu Hirose, Shizuoka 424-0102, Japan
Tel.: +81-543-64-5105 Fax: +81-543-64-5182